

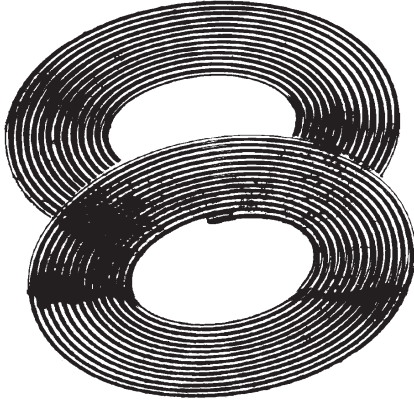

## COPPER TUBE TYPE L - FOR INTERIOR SERVICE



TYPE L is used for underground service lines, interior hot & cold water distribution lines, hot water & low pressure steam heating & condensate return lines.

### TYPE L - Soft - 60 and 100 foot coils - Pancake Tubing

Locke#	Size - Inside Diameter
H0706	1/4" Soft - 60 ft. coils Pancake Tubing
H0707	3/8" Soft - 60 ft. coils Pancake Tubing
H0708	1/2" Soft - 60 ft. coils Pancake Tubing
H0709	3/4" Soft - 60 ft. coils Pancake Tubing
H0710	1" Soft - 60 ft. coils Pancake Tubing
H0711	1 1/4" Soft - 60 ft. coils Pancake Tubing
H0712	1/2" Soft - 100 ft. coils Pancake Tubing
H0713	3/4" Soft - 100 ft. coils Pancake Tubing
H0730	1" Soft - 100 ft. coils Pancake Tubing

### TYPE L - Hard - 20 foot lengths

H0732	1/2" Hard 20 ft. lengths Tubing
H0733	3/4" Hard 20 ft. lengths Tubing
H0734	1" Hard 20 ft. lengths Tubing
H0735	1 1/4" Hard 20 ft. lengths Tubing
H0736	1 1/2" Hard 20 ft. lengths Tubing
H0737	2" Hard 20 ft. lengths Tubing



## TYPE M FOR DRAINAGE AND LOW PRESSURE SERVICE



TYPE M has thinner walls than types K or L. It is used for interior hot & cold water distribution lines, hot water & low pressure steam heating lines, chilled water lines & above ground sanitary drainage lines. Hard type sold 20 ft. lengths.

### Locke# Size - Inside Diameter

H0740	1/2" Hard 20 ft. lengths Tubing
H0741	3/4" Hard 20 ft. lengths Tubing
H0742	1" Hard 20 ft. lengths Tubing



## COPPER TUBE TYPE K - FOR GENERAL PLUMBING & HEATING

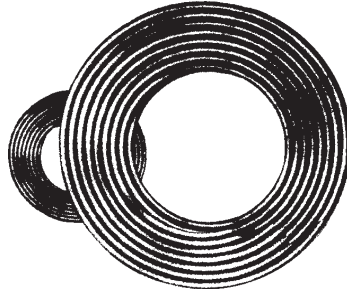

TYPE K SOFT COPPER is used for general plumbing & heating purposes. It is most frequently used for underground service lines. Sold in 60ft. coils. Priced per 100 ft.

### TYPE K - Soft - 60 foot and 100 foot coils - Pancake Tubing

Locke#	Size - Inside Diameter
H0700	1/2" Soft - 60 ft. coils
H0701	3/4" Soft - 60 ft. coils
H0702	1" Soft - 60 ft. coils
H0703	1/2" Soft - 100 ft. coils
H0704	3/4" Soft - 100 ft. coils
H0705	1" Soft - 100 ft. coils

### TYPE K - Hard - 20 foot lengths Tubing

H0756	1 1/2" Hard 20 ft. lengths
H0757	2" Hard 20 ft. lengths



## REFRIGERATION TUBE



Copper tube for refrigeration is generally the same as other copper tubing, but it is specially cleaned, dehydrated and sealed to make it suitable for use with air conditioning and refrigeration systems.

### SOFT - 50 foot coils

Locke#	Size - Outside Diameter
H0714	5/8" Soft - 50 ft. coils Refrigeration Tubing
H0715	1/4" Soft - 50 ft. coils Refrigeration Tubing
H0716	3/8" Soft - 50 ft. coils Refrigeration Tubing
H0717	1/2" Soft - 50 ft. coils Refrigeration Tubing
H0718	5/8" Soft - 50 ft. coils Refrigeration Tubing
H0719	3/4" Soft - 50 ft. coils Refrigeration Tubing
H0720	7/8" Soft - 50 ft. coils Refrigeration Tubing
H0721	1 1/8" Soft - 50 ft. coils Refrigeration Tubing

### HARD - 20 foot lengths - ACR

H0724	5/8" Hard - 20 ft. lengths Refrigeration Tubing
H0725	1/2" Hard - 20 ft. lengths Refrigeration Tubing
H0722	5/8" Hard - 20 ft. lengths Refrigeration Tubing
H0726	3/4" Hard - 20 ft. lengths Refrigeration Tubing
H0723	7/8" Hard - 20 ft. lengths Refrigeration Tubing
H0727	1 1/8" Hard-20 ft. lengths Refrigeration Tubing
H0728	1 3/8" Hard-20 ft. lengths Refrigeration Tubing
H0729	1 5/8" Hard-20 ft. lengths Refrigeration Tubing

# COPPER FITTINGS

## NIBCO 90° ELBOW COPPER x COPPER



Locke# Inside Diam.

H0001	1/4"
H0002	3/8"
H0003	1/2"
H0004	5/8"
H0005	3/4"
H0006	1"
H0007	1 1/4"
H0008	1 1/2"
H0009	2"

## NIBCO 90° REDUCING ELBOW COPPER x COPPER

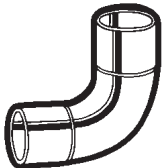

Locke# Inside Diam.

H0016	3/4" x 1/2"
H0018	1" x 3/4"

## NIBCO 90° ELLS COPPER x COPPER



Long Radius

Locke#	I.D.	O.D.
H0015	1/8"	1/4"
H0017	1/4"	3/8"
H0019	3/8"	1/2"
H0020	1/2"	5/8"
H0021	5/8"	3/4"
H0022	3/4"	7/8"
H0023	1"	1 1/8"
H0024	1 1/4"	1 7/8"

## NIBCO 90° ELBOW COPPER x FITTING

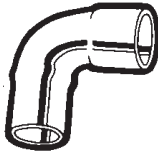

Locke# Inside Diam.

H0030	1/4"
H0032	1/2"
H0033	3/4"
H0034	1"
H0036	1 1/2"
H0031	2"

## NIBCO 90° ELBOW COPPER x FITTING

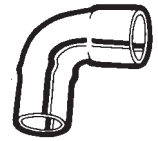

Long Radius

Locke#	I.D.	O.D.
H0037	3/8"	1/2"
H0038	1/2"	5/8"
H0039	5/8"	3/4"
H0040	3/4"	7/8"
H0041	1"	1 1/8"
H0048	1 1/4"	1 7/8"

## NIBCO 90° DROP EAR ELBOW COPPER x COPPER

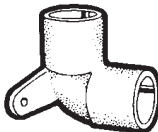

Locke# Inside Diam.

H0058	1/2"
-------	------

## NIBCO 45° ELBOW COPPER x FITTING COPPER x FITTING



Locke# Inside Diam.

H0026	1/2"
H0027	3/4"
Outside Diam.	
H0260	3/4"

## NIBCO 45° ELBOW COPPER x COPPER



Locke# Inside Diam.

H0042	1/2"
H0043	3/4"
H0044	1"
H0045	1 1/4"
H0046	1 1/2"
H0047	2"
Outside Diam.	
H0255	3/4"

## NIBCO TEE ADAPTERS COPPER TO COPPER TO COPPER



Locke# Inside Diam.

H0078	1/2" x 1/2" x 3/4"
H0077	3/4" x 1/2" x 1/2"
H0076	3/4" x 1/2" x 3/4"
H0075	3/4" x 3/4" x 1/2"
H0116	3/4" x 3/4" x 1"
H0085	1" x 1/2" x 1"
H0081	1" x 3/4" x 1/2"
H0086	1" x 3/4" x 3/4"
H0087	1" x 3/4" x 1"
H0083	1" x 1" x 1/2"
H0084	1" x 1" x 3/4"
H0117	1" x 1" x 1 1/4"
H0089	1 1/4" x 1 1/4" x 1/2"
H0090	1 1/4" x 1 1/4" x 3/4"
H0091	1 1/4" x 1 1/4" x 1"
H0118	1 1/4" x 1 1/4" x 1 1/2"
H0103	1 1/2" x 1 1/2" x 1/2"
H0104	1 1/2" x 1 1/2" x 3/4"
H0105	1 1/2" x 1 1/2" x 1"
H0106	1 1/2" x 1 1/2" x 1 1/4"
H0119	1 1/2" x 1 1/2" x 2"
H0108	2" x 2" x 3/4"
H0109	2" x 2" x 1"
H0110	2" x 2" x 1 1/4"
H0111	2" x 2" x 1 1/2"
H0107	2" x 2" x 1 1/2"

## NIBCO TEES COPPER TO COPPER TO COPPER

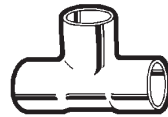

Locke# Inside Diam.

H0065	1/4"
H0066	3/8"
H0067	1/2"
H0068	3/4"
H0069	1"
H0070	1 1/4"
H0071	1 1/2"
H0072	2"

## NIBCO COUPLINGS COPPER x COPPER



Locke# Inside Diam.

H0145	1/8"
H0146	1/4"
H0147	3/8"
H0148	1/2"
H0149	5/8"
H0150	3/4"
H0151	1"
H0152	1 1/4"
H0153	1 1/2"
H0154	2"
Outside Diameter	
H0265	5/16"

## NIBCO COUPLING COPPER x COPPER



Without stop. Used in repairing small leaks in copper pipe and for regular coupling uses.

Locke#	
H0430	1/2" Coupling
H0431	3/4" Coupling

## NIBCO FLUSH BUSHINGS COPPER x FITTING

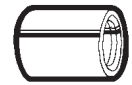

Locke# Inside Diam.

H0228	1/2" x 1/4"
H0229	1/2" x 3/8"
H0230	3/4" x 1/2"
H0231	1" x 1/2"
H0232	1" x 3/4"
H0233	1 1/4" x 3/4"
H0234	1 1/4" x 1"
H0235	1 1/2" x 1"
H0236	1 1/2" x 1 1/4"
H0238	2" x 1 1/2"
Outside Diameter	
H0290	3/4" x 5/8"
H0291	7/8" x 3/4"

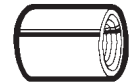

Threaded Bushing

H0296	1/2" x 1/4" x FIP
-------	-------------------

## NIBCO TUBE END CAP COPPER

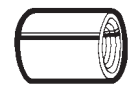

Locke# Inside Diam.

H0212	1/2"
H0213	3/4"
H0214	1"
H0215	1 1/4"
H0216	1 1/2"
H0217	2"

## NIBCO UNION COPPER x COPPER

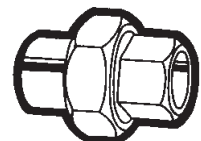

Locke# Inside Diam.

H0220	1/2"
H0221	3/4"
H0222	1"
H0223	1 1/4"
H0224	1 1/2"
H0225	2"

# COPPER FITTINGS

## NIBCO REDUCER COUPLING COPPER x COPPER



Locke#	Size
H0156	1/2" x 3/8" I.D.
H0157	3/8" x 1/4" I.D.
H0158	1/2" x 1/4" I.D.
H0159	1/2" x 3/8" I.D. 5/8" x 1/2" O.D.
H0161	3/4" x 1/2" I.D.
H0270	1/4" x 3/16" I.D. 3/8" x 5/16" O.D.
H0162	1" x 1/2" I.D.
H0163	1" x 3/4" I.D. 1 1/8" x 7/8" O.D.
H0164	3/4" x 5/8" I.D. 7/8" x 3/4" O.D.
H0165	5/8" x 1/2" I.D. 3/4" x 5/8" O.D.
H0166	1 1/4" x 1" I.D. 1 3/8" x 1 1/8" O.D.
H0171	1 1/2" x 1 1/4" I.D.
H0176	2" x 1 1/2" I.D.

## NIBCO FITTING REDUCER FITTING TO COPPER

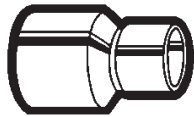

Locke#	Size
H0239	3/4" x 5/8"
H0240	3/4" x 1/2"
H0244	1" x 1/2"
H0241	1" x 3/4"
H0245	1 1/4" x 1/2"
H0246	1 1/4" x 3/4"
H0242	1 1/4" x 1"
H0247	1 1/2" x 1/2"
H0248	1 1/2" x 3/4"
H0249	1 1/2" x 1"
H0243	1 1/2" x 1 1/4"
H0251	2" x 1 1/2"
H0252	2" x 3/4"
H0253	2" x 1"
H0254	2" x 1 1/4"
H0256	2" x 1 1/2"

## NIBCO 90° FEMALE ELBOW COPPER TO FEMALE

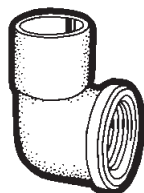

Locke#	Size
H0051	1/2"
H0052	3/4"
H0053	1 1/2" x 3/4"

## NIBCO 90° MALE ELBOW

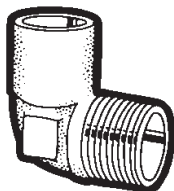

Locke#	Size
H0055	1/2"

## NIBCO 90° DROP EAR ELBOW COPPER TO FIP

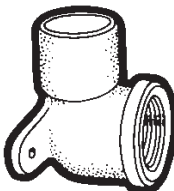

Locke#	Size
H0060	1/2"
H0061	3/4"

## NIBCO 90° HY-SET ELBOW COPPER TO FIP



Locke#	Size
H0063	1/2"

## NIBCO FEMALE TEE COPPER TO COPPER TO FEMALE



Locke#	Size
H0137	1/2"
H0138	3/4"

## NIBCO MALE ADAPTER COPPER TO MALE

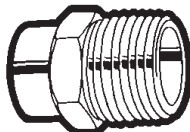

Locke#	Size
H0178	1/4"
H0179	3/8"
H0180	1/2"
H0182	3/4"
H0183	1"
H0184	1 1/4"
H0185	1 1/2"
H0186	2"

## NIBCO ADAPTER

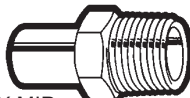

Locke#	Size
H0199	1/2" x 3/4"

## NIBCO FEMALE ADAPTERS COPPER TO FEMALE

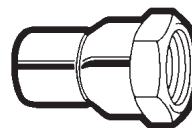

Locke#	Size
H0190	1/2"
H0192	3/4"
H0193	1"
H0194	1 1/4"
H0195	1 1/2"
H0196	2"

## NIBCO REDUCING ADAPTER

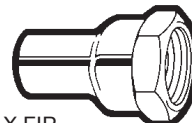

Locke#	Size
H0207	1/2" x 3/4"

## NIBCO DROP EAR ADAPTER

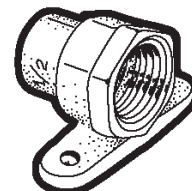

Locke#	Size
H0062	1/2" Drop Ear FIP Adapter

## BrassCraft® GARDEN HOSE X FIP

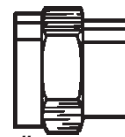

Locke#	Size
H0652	3/4" FIP to 3/4" Female Hose

## BrassCraft® GARDEN HOSE X FIP SWIVEL



Locke#	Size
H0645	3/4" FIP to 3/4" F Hose

## BrassCraft® MALE GARDEN HOSE X MIP

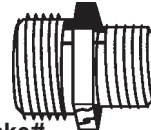

Locke#	Size
H0651	3/4" MIP to 3/4" Male Hose

## BrassCraft® COPPER STUB OUT



TYPE M. Used as stub-out, simply pressure test system then cut off stub-out (save for future use) and install valve or fixture.

Locke#	Size
M0500	1/2" x 6" Copper stub Type L
M0544	1/2" x 6" Copper stub Type M

COPPER PIPE

NIBCO

NIBCO

# FLARE FITTINGS

## BrassCraft® 9/16" MALE UNIONS

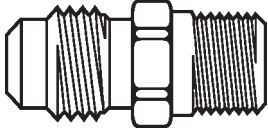

3/8" OD x 1/2" Male half unions, tapped 3/8" Female.

**Locke#**

- H0638** 3/8" OD x 1/2" Half Union  
**H0639** 3/8" OD x 3/8" Half Union

## BrassCraft® MALE GAS CONNECTOR

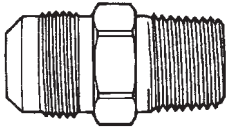

**Locke#**

- H0658** 15/16"-16 Flare x 1/2" MIP (tapped 3/8" FIP)  
**H0657** 15/16"-16 Flare x 3/4" MIP

## BrassCraft® FEMALE GAS CONNECTOR

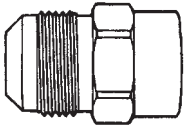

**Locke#**

- H0659** 15/16"-16 Flare x 1/2" FIP  
**H0656** 15/16"-16 Flare x 3/4" FIP

## BrassCraft® MALE ELBOW TUBE TO PIPE

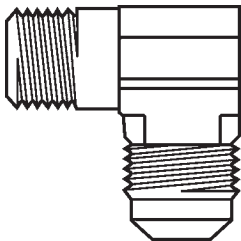

**Locke#**

- H0555** 49-6-6 3/8" Flare x 3/8" MIP Elbow

## BrassCraft® 9/16" FLARE NUTS

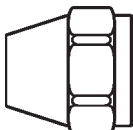

**Locke#**

- H0635** 3/8" O.D. Light Flare Nuts

## BrassCraft® FLARE NUTS

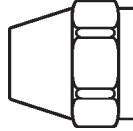

**Locke#**

- H0500** 1/4" Heavy Flare Nut  
**H0501** 3/8" Heavy Flare Nut  
**H0502** 1/2" Heavy Flare Nut  
**H0503** 5/8" Heavy Flare Nut  
**H0505** 7/8" Heavy Flare Nut

## BrassCraft® FULL FLARE TEES

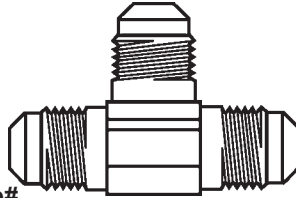

**Locke#**

- H0565** 3/8" Full Flare Tee  
**H0566** 1/2" Full Flare Tee  
**H0567** 5/8" Full Flare Tee

## BrassCraft® FULL FLARE UNIONS

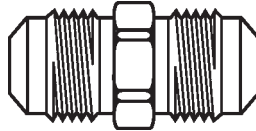

**Locke#**

- H0550** 3/8" Full Flare Union  
**H0551** 1/2" Full Flare Union  
**H0552** 5/8" Full Flare Union

## BrassCraft® HALF UNIONS FLARE X FIP

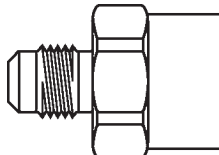

**Locke#**

- H0640** 3/8" x 1/2" Half Union

## BrassCraft® FINE THREAD FLARE CAP

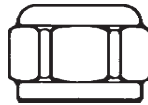

**Locke#**

- H0636** 9/16-24 Fine thread flare cap

## BrassCraft® HEAVY SHORT FLARE NUT



**Locke#**

Outside Diameter

- H0506** 1/4" Heavy Short Flare Nut  
**H0507** 3/8" Heavy Short Flare Nut  
**H0508** 1/2" Heavy Short Flare Nut  
**H0509** 5/8" Heavy Short Flare Nut  
**H0510** 3/4" Heavy Short Flare Nut

## BrassCraft® UNIONS

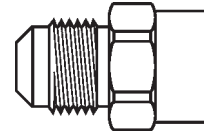

FLARE x FIP

**Locke#**

- H0513** 3/8" x 1/2" Union  
**H0514** 3/8" x 3/4" Union  
**H0518** 1/2" x 1/2" Union  
**H0519** 1/2" x 3/4" Union  
**H0522** 5/8" x 1/2" Union  
**H0523** 5/8" x 3/4" Union  
**H0524** 7/8" x 3/4" Union

FLARE x MIP

**Locke#**

- H0528** 1/4" x 1/4" Union  
**H0531** 3/8" x 1/4" Union  
**H0532** 3/8" x 3/8" Union  
**H0533** 3/8" x 1/2" Union  
**H0534** 3/8" x 3/4" Union  
**H0538** 1/2" x 1/2" Union  
**H0539** 1/2" x 3/4" Union  
**H0543** 5/8" x 1/2" Union  
**H0544** 5/8" x 3/4" Union  
**H0546** 7/8" x 3/4" Union

## BrassCraft® FLARE CAP

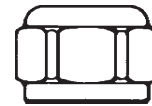

**Locke#**

Outside Diameter

- H0490** 1/4" Flare Cap  
**H0491** 3/8" Flare Cap  
**H0493** 5/8" Flare Cap

**H** COPPER PIPE

# COMPRESSION FITTINGS

BrassCraft®

## NEEDLE VALVE

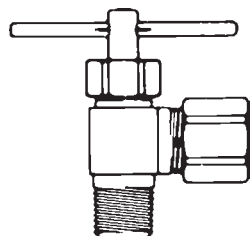

1/4" O.D. Tube x 1/8" M.I.P.  
90° angle & "T" handle

Locke#

H0643 1/4" O.D. Tube x 1/8" M.I.P.

BrassCraft®

## COMPRESSION STOP

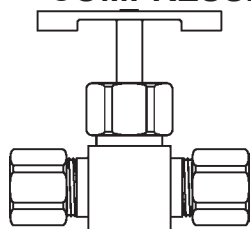

Compression Fittings on both ends. Has tee handle. Used for liquids.

Locke#

H0654 1/4" O.D. Compression Stop

H0655 3/8" O.D. Compression Stop

BrassCraft®

## COMPRESSION x FIP UNION

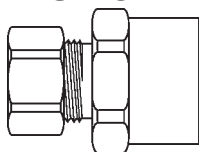

Locke#

H0581 1/4" Compression x 1/4" Union

H0587 3/8" Compression x 3/8" Union

H0588 3/8" Compression x 1/2" Union

H0594 5/8" Compression x 1/2" Union

H0599 7/8" Compression x 3/4" Union

BrassCraft®

## FLARE TO COMPRESSION UNION ADAPTOR

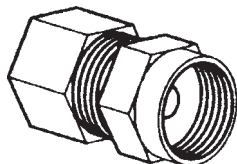

Locke#

H0495 3/8" Flare x 3/8" Compression Union Adaptor

H0496 1/2" Flare x 3/8" Compression Union Adaptor

BrassCraft®

## COMPRESSION SLEEVES



Locke#

H0575 1/4" Compression Sleeve

H0576 3/8" Compression Sleeve

H0577 1/2" Compression Sleeve

H0578 5/8" Compression Sleeve

BrassCraft®

## COMPRESSION NUTS



Locke#

H0570 1/4" Compression Nut

H0571 3/8" Compression Nut

H0572 1/2" Compression Nut

H0573 5/8" Compression Nut

BrassCraft®

## FULL COMPRESSION UNIONS

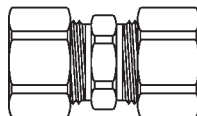

Locke#

H0620 1/4" x 1/4" Compression Union

H0621 3/8" x 3/8" Compression Union

H0622 1/2" x 1/2" Compression Union

H0623 5/8" x 5/8" Compression Union

H0626 7/8" x 7/8" Compression Union

BrassCraft®

## COMPRESSION x MIP UNION

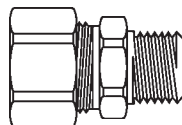

Locke#

H0600 1/4" Compression x 1/8" Union

H0601 1/4" Compression x 1/4" Union

H0603 1/4" Compression x 1/2" Union

H0606 3/8" Compression x 1/4" Union

H0607 3/8" Compression x 3/8" Union

H0608 3/8" Compression x 1/2" Union

H0612 1/2" Compression x 1/2" Union

H0616 5/8" Compression x 1/2" Union

H0617 5/8" Compression x 3/4" Union

H0618 7/8" Compression x 1/2" Union

H0619 7/8" Compression x 3/4" Union

BrassCraft®

## COMPRESSION UNIONS

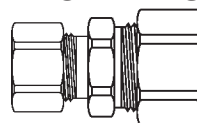

Reducing union tube both ends.

Locke#

H0624 3/8" x 1/4" Compression Union

H0625 5/8" x 3/8" Compression Union

BrassCraft®

## FULL COMPRESSION TEES

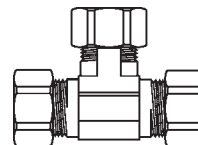

Locke#

H0630 1/4" x 1/4" x 1/4" Compression Tee

H0629 3/8" x 3/8" x 1/4" Compression Tee

H0631 3/8" x 3/8" x 3/8" Compression Tee

H0632 1/2" x 1/2" x 1/2" Compression Tee

H0633 5/8" x 5/8" x 5/8" Compression Tee

BrassCraft®

## COMPRESSION ELBOWS

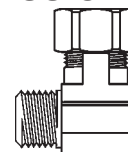

Locke#

H0634 3/8" x 3/8" Full Comp. Elbow

H0660 1/2" MIP x 3/8" Full Comp. Elbow

H0661 1/2" FIP x 3/8" Full Comp. Elbow

BrassCraft®

## COMPRESSION CAPS



Locke#

H0579 3/8" Compression Cap

H0580 5/8" Compression Cap

BrassCraft®

## NEEDLE VALVE KIT

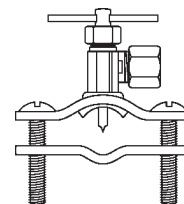

PNEV-NCV; for 3/8" to 1" tube. 1/4" OD Tube outlet. Consists of needle valve, saddle clamp, bolt & washer.

Locke#

H0644 Needle Valve Kit

COPPER PIPE

# PUSH-FIT CONNECTORS



## STRAIGHT COUPLINGS



Locke#

H0300 2100 1/2" Coupling

H0301 2100 3/4" Coupling

H0303 2100 1" Coupling

## REDUCING COUPLINGS

Locke#

H0302 2100 3/4"x1/2" Coupling

H0304 2100 1"x3/4" Coupling



## STRAIGHT CONNECTORS



Locke#

H0315 2100M 1/2" MNPT Conn.

H0316 2100M 3/4" MNPT Conn.

H0317 2100M 1" MNPT Conn.

H0310 2100F 1/2" FNPT Conn.

H0311 2100F 3/4" FNPT Conn.

H0312 2100F 1" FNPT Conn.

**Reducing Connector**

H0328 2100F 1/2"x3/4" FNPT Conn.

H0318 2100M 1/2 x 3/4 MNPT Conn.



## TEES



Locke#

H0330 2130 1/2" Tee

H0331 2130 3/4" Tee

H0332 2130 3/4"x3/4"x1/2" Tee

H0333 2130 3/4"x1/2"x3/4" Tee

H0334 2130 3/4"x1/2"x1/2" Tee

H0335 2130 1" Tee

H0336 2130 1"x1"x3/4" Tee



## ELBOWS



Locke#

H0320 2190 1/2"x1/2" Elbow

H0321 2190 3/4"x3/4" Elbow

H0322 2190 3/4"x1/2" Elbow

H0323 2190 1"x1" Elbow



## ELBOWS



Locke#

H0376 2190M 1/2 Quick Connect Elbow x MIP

H0377 2190F 1/2 Quick Connect Elbow x FIP



## DROP EAR ELBOW



Locke#

H0327 2101Q 1/2" FNPT Elbow



## END STOPS



Locke#

H0360 2103 1/2" End Stop

H0361 2103 3/4" End Stop

H0362 2103 1" End Stop



## BALL VALVE

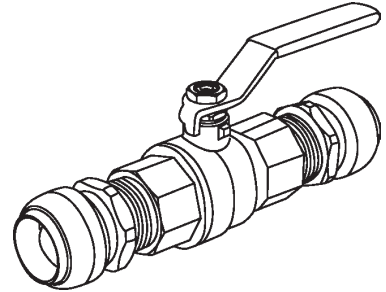

Locke#

H0350 2105 1/2" Ball Valve

H0351 2105 3/4" Ball Valve



## DISCONNECTING CLIP



Disconnecting a joint:

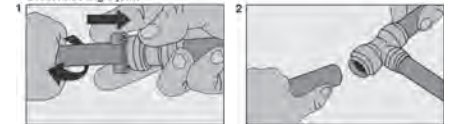

Locke#

H0370 2100RT 1/2" Disconnecting Clip

H0371 2100RT 3/4" Disconnecting Clip

H0372 2100RT 1" Disconnecting Clip



## SLIP COUPLING

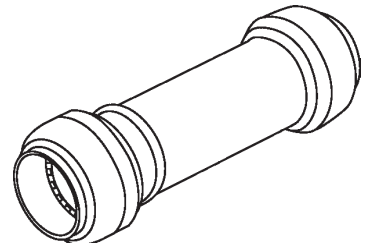

The SharkBite® Slip Coupling simplifies repair by doing the job that two couplings and extra pipe used to do. Only one end of the coupling has a stop, allowing the other end to slide freely over the end of a pipe. The fitting can be released with a disconnect tool and slid back onto the other end of the pipe for successful leak repair.

Locke#

H0306 U3008 1/2" Slip Coupling

H0307 U3016 3/4" Slip Coupling

H0308 U3020 1" Slip Coupling

COPPER PIPE

# SHARKBITE® PUSH-FIT CONNECTION SYSTEM



## 26pc. CONTRACTOR KIT

Orange kit with 2 each:

U008 1/2" couplings, U072 1/2" FNTP connectors,  
 U016 3/4" couplings, U088 3/4" FNTP connectors,  
 U058 3/4x1/2" couplings, U120 1/2" MNTP connectors,  
 U248 1/2" elbows, U134 3/4" MNTP connectors,  
 U256 3/4" elbows.

and 1 each:

U362 1/2" tee, U710 1/2" disconnecting clip,  
 U370 3/4" tee, U711 1/2" disconnecting tongs,  
 U514 1/2" end stop, U713 3/4" disconnecting tongs,  
 U518 3/4" end stop, U702 depth gauge/deburr tool.

### Locke#

H0359 26 piece Contractor Kit



## STRAIGHT COUPLINGS



### Locke#

H0800 U008 1/2" Coupling

H0801 U016 3/4" Coupling

H0803 U020 1" Coupling

## REDUCING COUPLINGS

### Locke#

H0802 U058 3/4" x 1/2" Coupling

H0804 U060 1" x 3/4" Coupling



## SHARKBITE® SLIP COUPLING

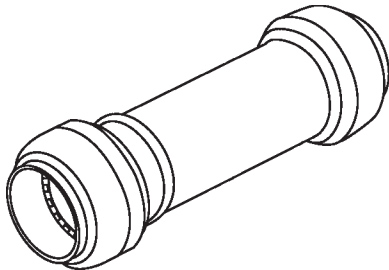

The SharkBite® Slip Coupling simplifies repair by doing the job that two couplings and extra pipe used to do. Only one end of the coupling has a stop, allowing the other end to slide freely over the end of a pipe. The fitting can be released with a disconnect tool and slid back onto the other end of the pipe for successful leak repair.

### Locke#

H0806 U3008 1/2" Slip Coupling

H0807 U3016 3/4" Slip Coupling

H0808 U3020 1" Slip Coupling



## STRAIGHT CONNECTORS



### Locke#

H0810 U072 1/2" FNPT Conn.

H0811 U088 3/4" FNPT Conn.

H0812 U094 1" FNPT Conn.

H0815 U120 1/2" MNPT Conn.

H0816 U134 3/4" MNPT Conn.

H0817 U140 1" MNPT Conn.

### Reducing Connector

H0828 U068 1/2" x 3/4" FNPT Conn.

H0818 U116 1/2" x 3/4" MNPT Conn.



## ELBOWS



### Locke#

H0820 U248 1/2" Elbow

H0821 U256 3/4" Elbow

H0822 U274 1/2" Elbow

H0823 U260 1" Elbow



## DROP EAR ELBOW



### Locke#

H0827 U334 1/2" FNPT Elbow



## TEES



### Locke#

H0830 U362 1/2" Tee

H0831 U370 3/4" Tee

H0832 U412 3/4"x3/4"x1/2" Tee

H0833 U444 3/4"x1/2"x3/4" Tee

H0834 U454 3/4"x1/2"x1/2" Tee

H0835 U374 1" Tee

H0836 U416 1"x1"x3/4" Tee



## BALL VALVE

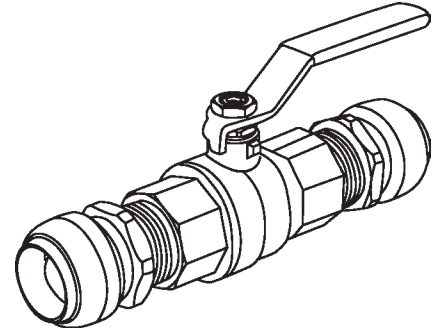

Cash Acme's full port ball valve now comes with SharkBite® connections for easy installation. The body is composed of highly forged brass, and features a single lever control.

**Note:** Slip Couplings should only be used on copper.

### Locke#

H0850 22222 1/2" Ball Valve

H0851 22185 3/4" Ball Valve



## END STOPS



### Locke#

H0860 U514 1/2" End Stop

H0861 U518 3/4" End Stop

H0862 U520 1" End Stop

COPPER PIPE

# SHARKBITE® PUSH-FIT CONNECTION SYSTEM



## WATER HEATER CONNECTOR



**Locke#**

- H0365** U3088FLEX18 18" Water Heater Connector 3/4" Sharkbite x 3/4" Comp
- H0366** U3088FLEX24 24" Water Heater Connector 3/4" Sharkbite x 3/4" Comp
- H0367** U3088FLEX18BV 18" Water Heater Connector 3/4" Sharkbite x 3/4" Comp with a Ball Valve



## TOILET CONNECTOR



**Locke#**

- H0873** U3531 1/4"x7/8" Toilet Connector Ballcock Threads



## FAUCET CONNECTOR



**Locke#**

- H0874** U3525 1/4"x1/2"F Faucet Connector 14 NPSM Threads



## STRAIGHT CONVERSION COUPLINGS



**Locke#**

- H0840** 1/2" Polybutylene x 1/2" Shark Bite Conversion Coupling
- H0841** 3/4" Polybutylene x 3/4" Shark Bite Conversion Coupling



## DISCONNECTING TONG

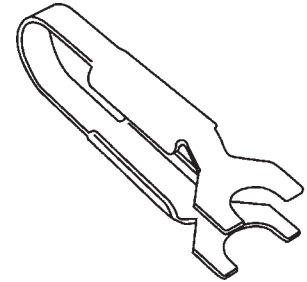

**Locke#**

- H0373** U711 1/2" Disconnecting Tongs
- H0374** U713 3/4" Disconnecting Tongs
- H0375** U715 1" Disconnecting Tongs



## DISCONNECTING CLIP



Disconnecting a joint:

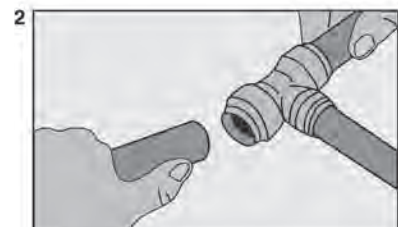
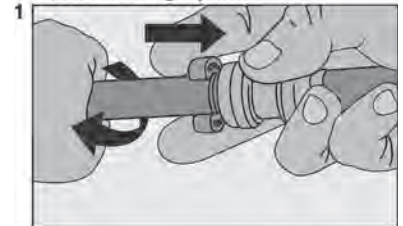

**Locke#**

- H0870** U710 1/2" Disconnecting Clip
- H0871** U712 3/4" Disconnecting Clip
- H0872** U714 1" Disconnecting Clip

H0841 and H0841 added on 1/30/2012

COPPER PIPE

# JOHN GUEST SUPER "SPEEDFIT®" "PUSH-IN" PIPE FITTINGS

## John Guest USA, Inc. SUPER "SPEEDFIT®" "PUSH-IN" PIPE FITTINGS

- Makes instant connections on most standard types of tubes.
- Simple - Insert copper or plastic pipe end into fitting - "Push-in" - and it's complete.
- Uses: dishwasher, ice maker, Delta faucet, hot water dispenser with copper extension & faucet shank connection.

## John Guest USA, Inc. MALE CONNECTOR

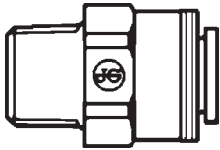

Locke#

H0901	1/4" Speedfit Male x 1/4" NPFT
H0913	1/4" Speedfit Male x 3/8" NPFT
H0902	3/8" Speedfit Male x 1/4" NPFT
H0903	3/8" Speedfit Male x 3/8" NPFT
H0904	3/8" Speedfit Male x 1/2" NPFT
H0905	1/2" Speedfit Male x 3/8" NPFT
H0906	1/2" Speedfit Male x 1/2" NPFT

## John Guest USA, Inc. SPEEDFIT TEES

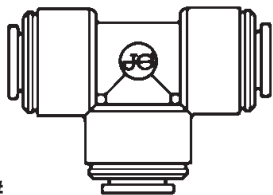

Locke#

H0910	1/4" Speedfit Union Tee
H0911	3/8" Speedfit Union Tee
H0912	1/2" Speedfit Union Tee
H0920	3/8" x 3/8" x 1/4" Reducing Tee

## John Guest USA, Inc. SPEEDFIT ELBOWS

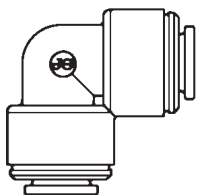

Locke#

H0930	1/4" Speedfit Union Elbow
H0931	3/8" Speedfit Union Elbow
H0932	1/2" Speedfit Union Elbow
H0940	3/8" x 1/4" Reducing Elbow
H0942	1/2" x 3/8" Reducing Elbow

## John Guest USA, Inc. END STOP CAP

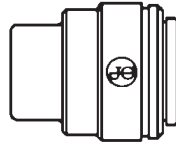

Locke#

H0960	1/4" Speedfit End Stop Cap
H0961	3/8" Speedfit End Stop Cap

## John Guest USA, Inc. FIXED ELBOW

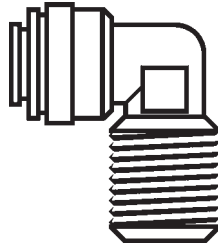

Locke#

H0953	1/4" Speedfit x 1/4" NPFT Elbow
H0954	3/8" Speedfit x 3/8" NPFT Elbow
H0955	5/8" Speedfit x 1/2" NPFT Elbow

## John Guest USA, Inc. BRASS FEMALE CONNECTOR

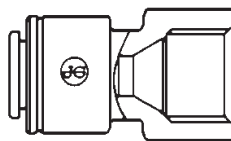

Locke#

H0968	1/4" OD x 1/4" FFL Brass Speedfit
H0969	3/8" OD x 1/4" FFL Brass Speedfit
H0967	3/8" OD x 3/8" FFL Brass Speedfit

## John Guest USA, Inc. 4-WAY CROSS

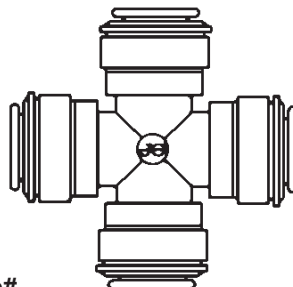

Locke#

H1030	3/8" Speedfit 4-Way Cross
-------	---------------------------

## John Guest USA, Inc. SPEEDFIT UNION CONNECTORS

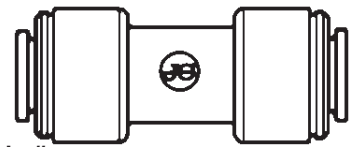

Locke#

H0970	1/4" Speedfit Union Connect.
H0973	5/16" Speedfit Union Connect.
H0971	3/8" Speedfit Union Connect.
H0972	1/2" Speedfit Union Connect
H0980	3/8" x 1/4" Reducing Union
H0981	3/8" x 5/16" Reducing Union
H0982	1/2" x 5/16" Reducing Union
H0983	1/2" x 3/8" Reducing Union

## John Guest USA, Inc. SPEEDFIT STRAIGHT VALVE

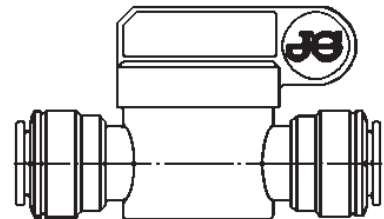

Locke#

H1050	1/4" Speedfit Straight Valve
H1051	3/8" Speedfit Straight Valve

## John Guest USA, Inc. REDUCER

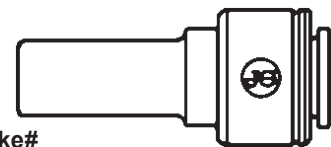

Locke#

H0990	3/8" Stem O.D. x 1/4" O.D.
H0992	1/2" Stem O.D. x 3/8" O.D.

## John Guest USA, Inc. PLUG



Locke#

H0964	3/8" Speedfit Plug
-------	--------------------

ALL SIZES SHOWN ARE OUTSIDE DIAMETER TUBING SIZES.

# JOHN GUEST SUPER "SPEEDFIT"® • "PUSH-IN" PIPE FITTINGS

## John Guest USA, Inc. FAUCET CONNECTOR

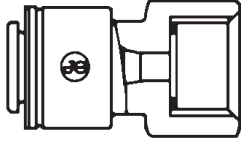

Locke#

**H1010** 1/4" Speedfit x 1/2" Faucet Shank Connector

**H1011** 3/8" Speedfit x 1/2" Faucet Shank Connector

## John Guest USA, Inc. CONNECTORS FOR ICE MACHINES & WATER COOLERS

Convert Compression to the Push on Fittings

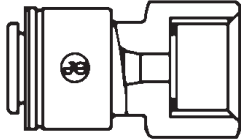

Locke#

**H1014** 3/8"x7/16" UNS faucet conn.

## John Guest USA, Inc. 2-WAY DIVIDER

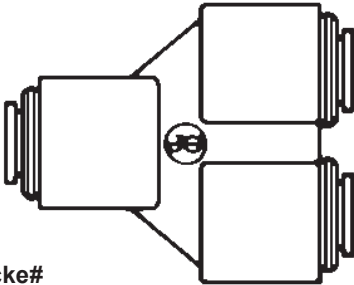

Locke#

**H1020** 3/8" Speedfit 2-Way Divider

## John Guest USA, Inc. CHECK VALVE

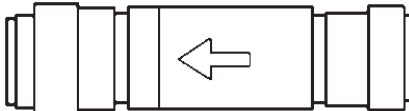

Locke#

**H1040** 3/8" Speedfit Check Valve

## John Guest USA, Inc. LOCKING CLIP

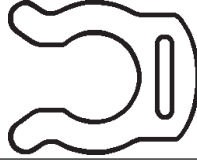

Locke#

**H1055** 1/4" Speedfit Locking Clip

**H1056** 3/8" Speedfit Locking Clip

## John Guest USA, Inc. PLUG-IN ELBOW

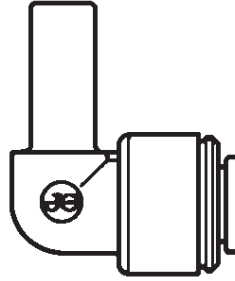

Locke#

**H0991** 3/8" Stem O.D. x 1/4" Tube O.D.

**H0989** 3/8" Stem O.D. x 3/8" Tube O.D.

## John Guest USA, Inc. SPEEDFIT ANGLE VALVE



Locke# Tube x Male x Female

**H1052** 1/4 x 3/8 x 3/8 Angle Stop Valve

**H1053** 3/8 x 3/8 x 3/8 Angle Stop Valve

**WE DO MORE THAN  
JUST MEET OUR  
COMPETITION,  
WE BEAT THEM.  
COMPARE OUR  
PRICES AND SAVE!!**



**H** | COPPER PIPE

ALL SIZES SHOWN ARE OUTSIDE DIAMETER TUBING SIZES.

# VIEGA PROGRESS® FITTINGS



## BRONZE COPPER PROGRESS® TO MALE NPT FITTINGS



Locke#

R2671 1/2" P x 1/2" M NPT

R2672 1/2" P x 3/4" M NPT

R2674 3/4" P x 3/4" M NPT

R2677 1" P x 1" M NPT

R2817 1 1/4" P x 1 1/4" M NPT

R2679 1 1/2" P x 1 1/2" M NPT



## PROGRESS® COPPER TO COPPER 90° ELBOWS



Locke#

R2620 1/2" P x P Elbow ProPress®

R2621 3/4" P x P Elbow ProPress®

R2622 1" P x P Elbow ProPress®

R2623 1 1/4" P x P Elbow ProPress®

R2624 1 1/2" P x P Elbow ProPress®

R2625 2" P x P Elbow ProPress®



## BRONZE ELBOW DROP 90° COPPER PROGRESS® TO FEMALE NPT with Wall Plate



Locke#

R2660 1/2" P x F NPT 90° Elbow

R2661 3/4" P x F NPT 90° Elbow



## BRONZE COPPER PROGRESS® TO FEMALE NPT FITTINGS



Locke#

R2681 1/2" P x 1/2" F NPT

R2682 1/2" P x 3/4" F NPT

R2684 3/4" P x 3/4" F NPT

R2687 1" P x 1" F NPT

R2816 1 1/4" P x 1 1/4" F NPT

R2688 1 1/2" P x 1 1/2" F NPT

R2689 2" P x 2" F NPT



## COPPER PROGRESS® TO COPPER SWEAT 90° ELBOWS



Locke#

R2640 1/2" P ProPress® x Sweat Elbow

R2641 3/4" P ProPress® x Sweat Elbow

R2642 1" P ProPress® x Sweat Elbow

R2643 1 1/4" P ProPress® x Sweat Elbow

R2644 1 1/2" P ProPress® x Sweat Elbow

R2645 2" P ProPress® x Sweat Elbow



## BRONZE PROGRESS® COPPER TO COPPER BALL VALVE



Locke#

R2610 1/2" P x P Ball Valve

R2611 3/4" P x P Ball Valve

R2612 1" P x P Ball Valve

R2613 1 1/4" P x P Ball Valve

R2614 1 1/2" P x P Ball Valve

R2615 2" P x P Ball Valve



## PROGRESS® COPPER TO COPPER COUPLINGS



Locke#

R2694 1/2" P x P ProPress® Coupling

R2695 3/4" P x P ProPress® Coupling

R2696 1" P x P ProPress® Coupling

R2815 1 1/4" P x P ProPress® Coupling

R2698 1 1/2" P x P ProPress® Coupling

R2699 2" P x P ProPress® Coupling



## PROGRESS® COPPER TO COPPER 45° ELBOWS



Locke#

R2650 1/2" P x P 45° Elbow ProPress®

R2651 3/4" P x P 45° Elbow ProPress®

R2652 1" P x P 45° Elbow ProPress®

R2653 1 1/4" P x P 45° Elbow ProPress®

R2654 1 1/2" P x P 45° Elbow ProPress®

R2655 2 1/2" P x P 45° Elbow ProPress®



## PROGRESS® COPPER CAPS



Locke#

R2775 1/2" Copper ProPress® Cap

R2776 3/4" Copper ProPress® Cap

R2777 1" Copper ProPress® Cap

R2780 1 1/4" Copper ProPress® Cap

R2778 1 1/2" Copper ProPress® Cap

R2779 2" Copper ProPress® Cap

COPPER PIPE

# VIEGA PROGRESS® FITTINGS



## PROGRESS® COPPER TEES



### Locke#

R2781	1/2" ProPress® Tee
R2782	3/4" ProPress® Tee
R2783	3/4" x 1/2" x 1/2" ProPress® Tee
R2784	3/4" x 1/2" x 3/4" ProPress® Tee
R2785	3/4" x 3/4" x 1/2" ProPress® Tee
R2786	1" ProPress® Tee
R2797	1" x 1/2" x 3/4" ProPress® Tee
R2798	1" x 3/4" x 1/2" ProPress® Tee
R2799	1" x 3/4" x 3/4" ProPress® Tee
R2800	1" x 3/4" x 1" ProPress® Tee
R2801	1" x 1" x 1/2" ProPress® Tee
R2802	1" x 1" x 3/4" ProPress® Tee
R2787	1 1/4" ProPress® Tee
R2788	1 1/2" ProPress® Tee
R2792	1 1/2" x 1 1/2" x 1/2" ProPress® Tee
R2790	1 1/2" x 1 1/2" x 3/4" ProPress® Tee
R2791	1 1/2" x 1 1/2" x 1" ProPress® Tee
R2789	2" ProPress® Tee
R2793	2" x 2" x 1/2" ProPress® Tee
R2794	2" x 2" x 3/4" ProPress® Tee
R2795	2" x 2" x 1 1/4" ProPress® Tee
R2796	2" x 2" x 1 1/2" ProPress® Tee

## RIDGID

### PROGRESS TOOL



### Locke#

T1220	RP330	Propress Tool
T1221	27968	RP330 18v Battery only



## PROGRESS® COPPER REDUCERS



### Locke#

R2803	3/4" x 1/2" ProPress® Reducer
R2804	1" x 1/2" ProPress® Reducer
R2805	1" x 3/4" ProPress® Reducer
R2806	1 1/4" x 3/4" ProPress® Reducer
R2807	1 1/4" x 1" ProPress® Reducer
R2808	1 1/2" x 3/4" ProPress® Reducer
R2809	1 1/2" x 1" ProPress® Reducer
R2810	1 1/2" x 1 1/4" ProPress® Reducer
R2811	2" x 3/4" ProPress® Reducer
R2812	2" x 1" ProPress® Reducer
R2813	2" x 1 1/4" ProPress® Reducer
R2814	1" x 1 1/2" ProPress® Reducer

## RIDGID

### PROGRESS JAWS



### Locke#

T1223	76652	1/2" ProPress Jaw
T1224	76657	3/4" ProPress Jaw
T1225	76662	1" ProPress Jaw
T1226	76667	1 1/4" ProPress Jaw
T1274	22678	1 1/2" Jaw for Pex

## RIDGID

### PROGRESS JAWS



### Locke#

T1283	22958	1/2" Jaw for Pex
T1284	22968	3/4" Jaw for Pex
T1285	22973	1" Jaw for Pex



## PROGRESS® BRONZE EXTENDED REPAIR COUPLING - NO STOP



No Stops allows for easy repairs.

### Locke#

R2820	1/2" ProPress® Coupling no stop
R2821	3/4" ProPress® Coupling no stop
R2822	1" ProPress® Coupling no stop
R2823	1 1/4" ProPress® Coupling no stop
R2824	1 1/2" ProPress® Coupling no stop
R2825	2" ProPress® Coupling no stop



**H** | COPPER PIPE