

CEILING FANS, DOWNRODS, WALL FANS & RANGE HOODS

BROAN EUROPA HUGGER 5 BLADE OAK/WALNUT

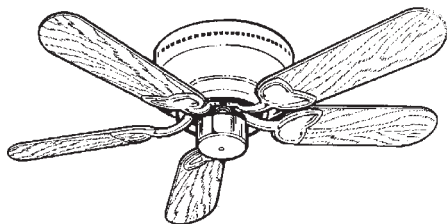

Install directly to ceiling with no down rod, 3 capacitor, 5 blade, reversible blades, 5 Year Warranty.

Locke#

P4527	PH416AB	42" Antique Brass
P4528	PH416PB	42" Polished Brass
P4529	PH416PW	42" White/Brass
P4530	PH416WW	42" White
P4531	PH516AB	52" Antique Brass
P4532	PH516PB	52" Polished Brass

BROAN EUROPA DUAL MOUNT 5 BLADE

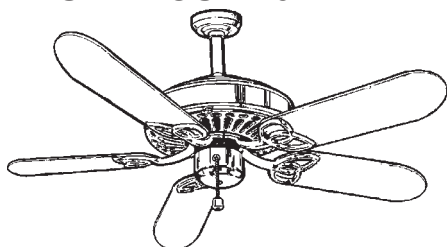

Solid housing, 3 Capacitor, dual mount with down rod or flush, 5 blade, reversible blades, 5 Year Warranty.

Locke#

P4535	P402 PB	42" Polished Brass
P4536	P402 PW	42" White/Brass
P4537	P402 WW	42" White
P4538	P502 AB	52" Antique Brass
P4539	P502 PB	52" Polished Brass
P4540	P502 WB	52" White/Brass

CEILING FAN DOWN RODS



Locke#

P3172	CFDR1WW	12" White
P3176	CFDR1AB	12" Antique Brass
P3177	CFDR1PB	12" Polished Brass
P3173	CFDR18WW	18" White
P3180	CFDR18PB	18" Polished Brass
P3174	CFDR2WW	24" White
P3183	CFDR2PB	24" Polished Brass
P3175	CFDR3WW	36" White
P3189	CFDR4PB	48" Polished Brass

BROAN WALL FAN

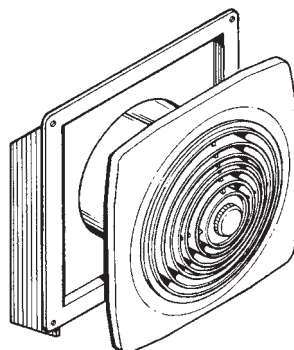

8" Thru the Wall Fan. 180 CFM

Locke#

P8062	509	8" Thru the Wall Fan	180 CFM
-------	-----	----------------------	---------

BROAN WALL FAN

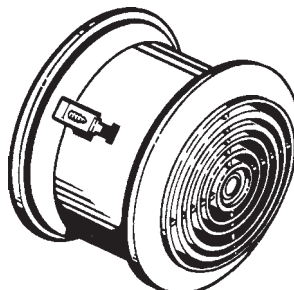

6" Thru the Wall Fan. 90 CFM

Locke#

P8060	512	6" Room to Room Fan	90 CFM
-------	-----	---------------------	--------

BROAN WALL FAN

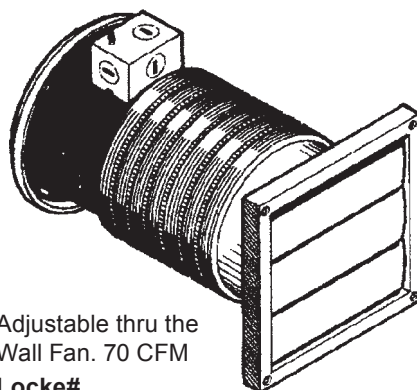

Adjustable thru the Wall Fan. 70 CFM

Locke#

P8061	512M	70 CFM Adjustable	Thru the Wall Fan
-------	------	-------------------	-------------------

BROAN 42000 SERIES RANGE HOOD

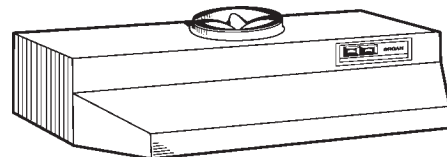

A two-speed economy, round ducted range hood featuring top-of-the-line quality at a terrific value.



P3211
Sold
separate

- Washable aluminum filter
- HVI certified 190 CFM, 6.0 Sones - vertical
- Two-speed rocker-type fan control
- Bright Lighting
- 7" round duct
- Contemporary styling

Locke#

P2506	30" White 42000 Series Range hood
P2507	30" Almond 42000 Series Range hood
P2508	30" Stainless Steel 42000 Series Range hood
P2509	36" White 42000 Series Range hood
P2510	36" Almond 42000 Series Range hood
P2511	36" Stainless Steel 42000 Series Range hood
P3211	7" Damper For 42000 Series

BROAN 41000 SERIES MICROTEK SYSTEM I RANGE HOOD

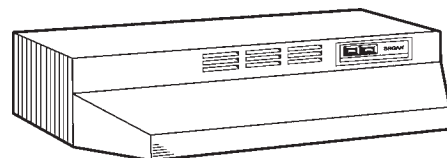

A two-speed economy duct-free range hood, featuring top-of-the-line quality.

- Uses exclusive Microtek System I Filter
- Two-speed rocker-type fan control
- Mixed-flow fan blade
- Bright Lighting
- Contemporary styling

	White	Almond	Stainless Steel
30"	P2500	P2501	P2502
36"	P2503	P2504	P2505
P2515	Filter for Ductless Range Hood		

HVAC

BROAN HEATER/FAN/LIGHT

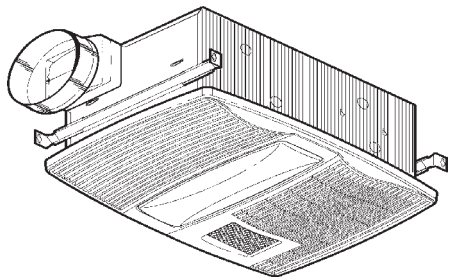

A small footprint combined with high-level performance.

- Heater/Fan/Light brings convenient, comforting warmth to your bathroom
- Nearly silent operation - 0.9 Sone, 110 CFM fan
- Quiet, high-output 1500 watt heater with exclusive PowerHeat design
- Bright 120 watt lighting (2x 60W)
- 7 watt nightlight capacity
- Requires a dedicated 20 amp circuit
- 17½" x 11¼" x 7⅝" housing
- Energy Stat Compliant

Locke#

P1525 QTX110HL Heater/Fan/Light, 110 CFM, .9 Sones

BROAN ULTRASILENT FANS

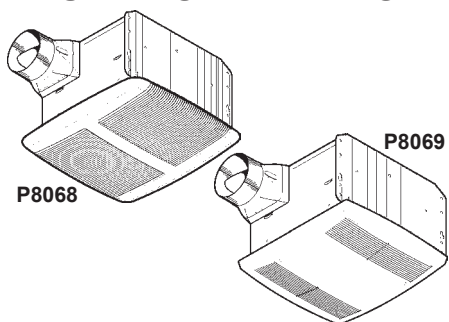

- Includes 4" round duct connector.
- UL listed for use over bathtubs and showers when connected to a GFCI protected branch circuit.
- Energy Stat Compliant

Locke#

P8068 QTR080 Ultrasilent Fan 80 CFM, 1.0 Sones

P8069 QTR080L Ultrasilent Fan/Light 80 CFM, 1.0 Sones

P8070 QTR110 Ultrasilent Fan 110 CFM, 1.5 Sones

P8071 QTR110L Ultrasilent Fan/Light 110CFM,1.5 Sones

BROAN VENTILATION FAN WITH HEATER AND ENERGY EFFICIENT LIGHTING

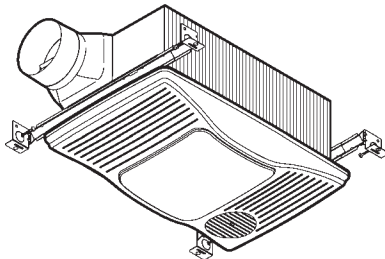

- 2.0 sone, 100 CFM ventilation fan
- 1500-watt directionally adjustable heater
- Requires a dedicated 20 amp circuit
- HVI Certified
- 1 year warranty

It's a Ventilation Fan with a Directional Heater and Your Choice of Lighting.

Locke#

P1416 100HFL Vent, Heater and Energy efficient lighting 2sones

BROAN RECESSED FAN LIGHT

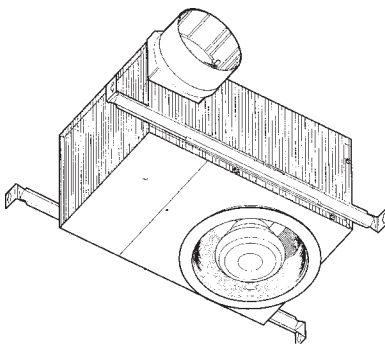

Recessed lights are popular lighting solutions. But Broan took it a step further by incorporating powerful ventilation in the same design.

- Centrifugal fan delivers 70 CFM
- HVI-certified 2.0 Sones
- Trim matched to designs of major recessed light manufacturers
- Multiple units can easily be used
- Uses a 75 watt bulb
- UL Listed for use over bathtubs and showers when connected to a GFCI protected branch circuit with PAR-type bulb
- Not for use over cooking surfaces
- Type IC, airtight housing

Locke#

P1546 744 6" Recessed Fan Light, 70 cfm, 1.5 sones

BROAN HEATER/FAN/LIGHT COMBINATIONS

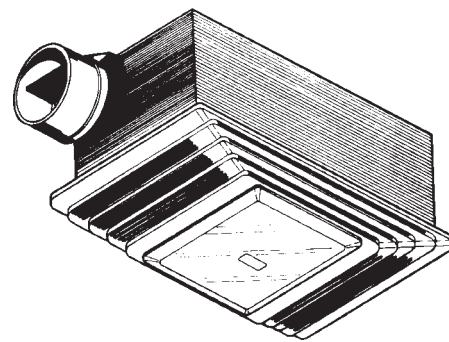

Quiet, efficient ventilation, bright lighting, instant warmth or any combination. Provides the ultimate in bathroom comfort. Features an efficient, 1300 watt fan-forced heater for warmth, a high performance exhaust fan to remove moisture & odors & a bright 100 watt light for convenience. No back drafts. Easy installation.

Locke#

P1535 655 Heater/Fan/Light Combination, 70 CFM, 4.0 Sones, Replaces Aubrey 7000

P1542 656 Heater/Light Combination, does NOT include fan, Replaces Aubrey 7001

P1543 658 Heater/Fan Combination, 70 CFM, 4.0 Sones, does NOT include light, Replaces Aubrey 7003

P1532 654H Housing Only

P1533 655F Finnish Kit for HVL

P1530 658F Finnish Kit for HV

BROAN LENS FOR BROAN HEATER/FAN/LIGHT COMBO.

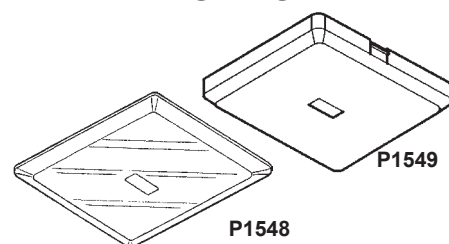

Locke#

P1548 S97011813 Lens for Broan 655, 656, 678 OLD

P1549 S97013578 Lens for Broan 655, 656, 678 NEW

BROAN

ULTRA SILENT SERIES HUMIDITY SENSING EXHAUST FAN

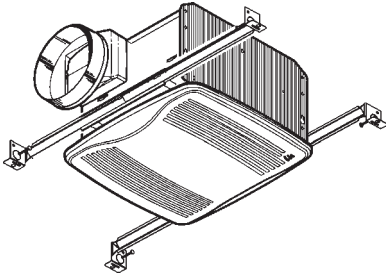

- 0.7 Sones
- 110 CFM
- Sensaire® technology detects the rapid rise in humidity over time
- Auto shut-off time is adjustable from 5 to 60 minutes
- Helps prevent lingering, excessive humidity which can cause mold
- Humidity is sensed at the ceiling where it is most prevalent
- Hanger bars for Easy, Fast and Universal installation in all types of construction
- UL Listed for use over bathtubs and showers when connected to a GFCI protected branch circuit.
- 6" ducting for superior performance

ENERGY STAR® qualified Sensaire® technology detects rapid increases in moisture levels at the ceiling, where steam and humidity naturally rise.

An automated solution to fight excess humidity and mold. Adjust the sensitivity level and run-time. Just beneath the drop-down grille are easy-to-adjust sensitivity and run-time controls. Choose your preference, set with a screwdriver and forget it. Of course, you can always override the sensor at the touch of a switch. Since you never have to worry about turning the fan on, Broan Ultra Silent™ is ideal for problem areas in residential, institutional and light-commercial applications. Our exclusive Sensaire® technology is a perfect solution for high-traffic bathrooms, or a kid's bathroom. It turns off automatically, and that saves money.

Humidity sensing fans are ideal for anyone who leaves the house before humidity is properly vented. With a fan this quiet, you can't forget to turn it off when the job is done. That saves energy and money.

Locke#

P1517 QTXE110S Ultra Silent Series Humidity Sensing Exhaust Fan

BROAN

HUMIDITY SENSING ULTRA QUIET FAN / LIGHT / NIGHTLIGHT

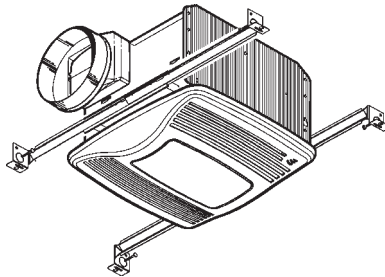

- 100W Incandescent Light (sold separately), 4W nightlight (sold separately)
- 0.9 Sones
- 110 CFM
- Sensaire® technology detects the rapid rise in humidity over time
- Auto shut-off time is adjustable from 5 to 60 minutes
- Helps prevent lingering, excessive humidity which can cause mold
- Humidity is sensed at the ceiling where it is most prevalent
- Includes hanger bar system for fast and flexible installation in all types of construction.
- UL Listed for use over bathtubs and showers when connected to a GFCI protected branch circuit.
- 6" ducting for superior performance

ENERGY STAR® qualified Sensaire® technology detects rapid increases in moisture levels at the ceiling, where steam and humidity naturally rise.

An automated solution to fight excess humidity and mold. Adjust the sensitivity level and run-time. Since you never have to worry about turning the fan on, Broan Ultra Silent™ is ideal for problem areas in residential, institutional and light-commercial applications. Our exclusive Sensaire® technology is a perfect solution for high-traffic bathrooms, or a kid's bathroom. It turns off automatically, and that saves money.

Humidity sensing fans are ideal for anyone who leaves the house before humidity is properly vented. With a fan this quiet, you can't forget to turn it off when the job is done. That saves energy and money.

Locke#

P1518 QTX110SL Humidity Sensing/Ultra Quiet Fan/Light/Nightlight

BROAN

HUMIDITY SENSING ULTRA QUIET FAN / FLUORESCENT LIGHT / NIGHTLIGHT

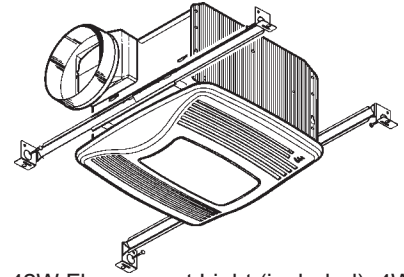

- 42W Fluorescent Light (included), 4W nightlight (sold separately)
- 0.7 Sones
- 110 CFM
- UL Listed for use over bathtubs and showers when connected to a GFCI protected branch circuit.
- 6" ducting for superior performance
- ENERGY STAR® qualified

Sensaire® technology detects rapid increases in moisture levels at the ceiling. An automated solution to fight excess humidity and mold. Adjust the sensitivity level and run-time. Since you never have to worry about turning the fan on, Broan Ultra Silent™ is ideal for problem areas in residential, institutional and light-commercial applications. Humidity sensing fans are ideal for anyone who leaves the house before humidity is properly vented. With a fan this quiet, you can't forget to turn it off when the job is done. That saves energy and money.

Locke#

P1519 QTXE110SFLT Humidity Sensing/Ultra Quiet Fan/Light/Nightlight

BROAN

FLUORESCENT FAN/LIGHT COMBINATION

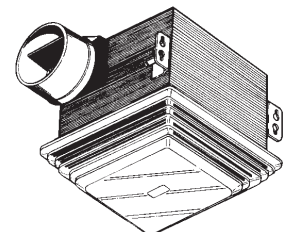

Built-in light-diffusing lens accepts 13W fluorescent lamp (Bulb not included).

Locke#

P2201 680FLT Fluorescent Fan/Light Combination, 100 CFM, 4 Sones, 4" round duct

BROAN FAN/LIGHT COMBINATIONS

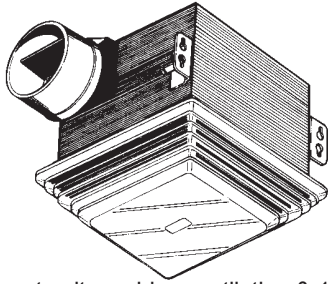

Compact unit provides ventilation & 100W light capacity in 1 unit. Features a molded plastic grille & plug-in lifetime lubricated motor. Quiet damper prevents back drafts.

Locke#

P1544 678 Fan/Light Combination, 50 CFM, 2.5 Sones, 3" round duct, for bathrooms up to 45 sq. ft., Replaces Aubrey 7555

P1590 2677H Housing Only for P1544

P1591 2678F Motor & Trim for P1544

BROAN BATH EXHAUST FAN

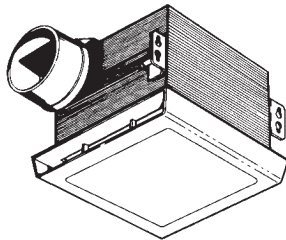

High exhaust capacity & low sound levels mark these **top-of-the-line** ceiling fans. Equipped with built-in mounting ears, bath fans feature durable dampers preventing cold back drafts. All units are UL listed for use above baths and showers when connected to a GFCI protected branch circuit. 110 CFM

Locke#

P8065 676 110 CFM Bath Fan



70CFM RECESSED FAN/ LIGHT



- 4.0 Sones
- 4" Duct Adaptor with Built-In Damper
- Exhaust Capacity up to 85 sq. ft.

Locke#

P1048 BFR704L 70 CFM Fan Light

BROAN LOSONE VENTILATOR

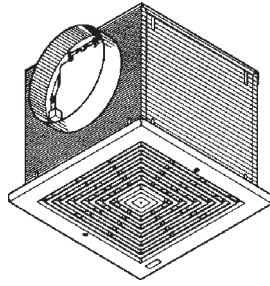

- 8" round duct. (200/250/300 CFM)
- Ducted horizontally, vertically or in-line.

Locke#

P8072 L200 200 CFM Losone Ventilator, 1.7 Sones

P8073 L300 300 CFM Losone Ventilator, 2.9 Sones

BROAN ECONOMY CEILING/WALL FANS

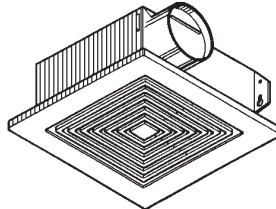

Quiet, Powerful Ventilation. Lifetime Lubricated Motor. Matte White Grille.

Locke#

P1538 688 Economy ceiling/wall fan, 50 CFM, 4.0 Sones, 3" round duct, for bathrooms up to 45 sq. ft., Replaces Aubrey 7550

P1539 1667H Housing Only for 50 CFM Vent Fan

P1540 1688F Motor & Trim for 50 CFM Vent Fan

P7196 690 60 CFM Upgrade kit for 688 fans



50CFM BATH FAN



- 3.5 Sones
- 3" Duct Adaptor with Built-In Damper
- Exhaust Capacity up to 60 sq. ft.

Locke#

P1049 BF503 50 CFM bath fan with 3" Duct Adaptor

BROAN BATH EXHAUST FAN

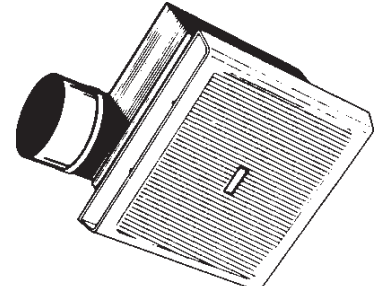

Centrifugal blower wheel, 4 pole 1500 RPM motor for high performance at low sound level. Quiet plastic damper. Damper/duct connector fits 4" duct.

Locke#

P7195 684 80 CFM Bath Exhaust Fan 2.5 Sones

BROAN DUCT FREE FAN

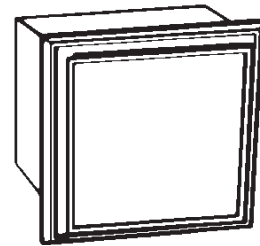

Requires NO Duct work. Combines efficient air circulation with minimum sound. Replaceable activated charcoal filter. Whisper quiet fan.

Locke#

P1531 682 Duct Free Fan, Replaces Aubrey 7659

BROAN ROOF CAP

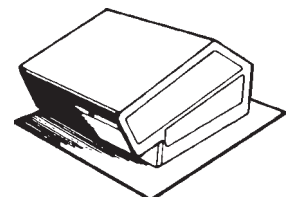

- Steel, black enamel finish
- Backdraft damper and bird screen

Locke#

P8063 634 Cap for 3 1/4" x 10" or up to 8" round duct

P8064 636 Roof Cap for 3" or 4" Round Duct

BROAN BULB HEATERS

Silent, infrared bulb heaters provide instant sunshine, warmth, and comfort in the bathroom without turning up the central thermostat. Features 250 watt R40 infrared bulb(s), attractive matte white grille, and quiet dampers. (Bulb(s) not included.)

2 Bulb Heater And Exhaust Fan

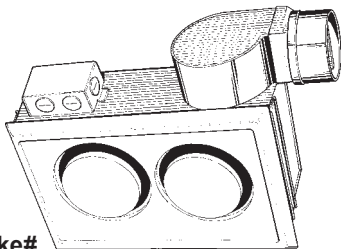

Locke#
P1534 164 Two-bulb heater/fan, 70 CFM, 3.5 sones, UL Listed for 60° C wiring, replaces Aubrey 7201

P1527 164F Finish assembly (grill) for Model 164

2 Bulb Heater

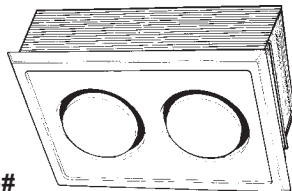

Locke#
P1541 163 Two-bulb heater, UL Listed for 75° C wiring, replaces Aubrey 7200

1 Bulb Heater And Exhaust Fan

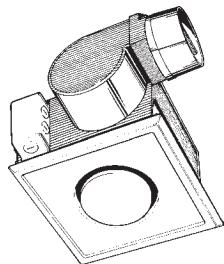

Locke#
P1597 162 One-bulb heater/fan, 70 CFM, 3.5 series, UL Listed for 60° C wiring

1 Bulb Heater

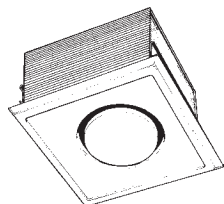

Locke#
P1547 161 One-bulb heater, UL Listed for 75° C wiring

BROAN LOW PROFILE CEILING HEATER



Provides even heat from a unit that extends only 2½" from the ceiling.

- Anodized aluminum construction
- Attractive, satin-finish aluminum "slimline" grille
- Chrome alloy, wire element provides instant heat
- Built-in fan disperses heat evenly
- Automatic overheat protection
- Lifetime lubricated motor
- Simple, quick surface installation
- Mounts easily to any standard 3¼", 3½", or 4" ceiling electrical box.

Volts	Watts	Amps	BTU	Color
120	1250	11	4266	Satin Aluminum

Locke#
P1598 154 Ceiling Heater 1250W 120V

BROAN "COMFORT-FLO" HEATER

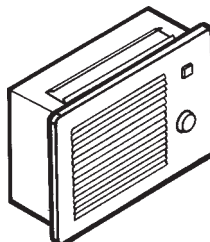

Fan forced wall heaters, perfect for the bathroom or other areas.

- Attractive grille styling and color options available
- Heavy duty steel grille and steel heater fan housing
- Built-in, snap-action thermostat automatically maintains desired temperature.
- 4 wattage/voltage options available

Locke#
P1537 174 Comfort-Flo Heater, Matte White, 750/1500 @ 120v, 1125@ 200v, 1500@ 240v

LEVITON MULTI-CONTROL

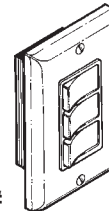

Three independent 120V, 60 cycle, 15A circuits

Locke#
P1536 1755I Ivory Heater/Fan/Light Control
P3432 1755W White Heater/Fan/Light Control
P8402 1755T Lite Almond Heater/Fan/Light Control

BROAN MODEL 77D MULTI-CONTROL

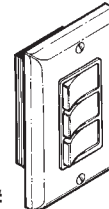

3Way 4Function Control 120V, 60 cycle, 15A circuits

Locke#
P1523 77DW White 3Way 4Function Heater/Fan/Light Control
P1524 77DV Ivory 3Way 4Function Heater/Fan/Light Control

LEVITON MULTI-CONTROL

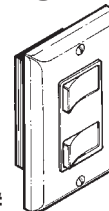

Two independent 120V, 60 cycle, 15A circuits

Locke#
P1545 1754I Ivory Multi-Control
P3433 1754W White Multi-Control
P9206 1754T Light Almond Multi-Control

BROAN DUCT CONNECTORS



Locke#
P1528 97003932 4" Duct Connector
P1529 97016377 3" Duct Connector

HVAC