

SUMP PUMPS



A.Y. McDonald Mfg. Co.

SUMP PUMPS



Features:

- Rustproof construction
- Clog proof vortex impeller
- Includes check valve and hose adapter
- High torque capacitor-start motors
- Easy to install. Easy to service.
- Available in 1/4, 1/3 and 1/2 HP models.
- Multipurpose replaceable piggyback float saves installation time.
- Automatic or manual operation
- Float can be used attached to the pump, the discharge pipe or to the basin wall
- Float chamber easily opened for cleaning
- Adjustable pump down range
- UL Listed, CSA approved

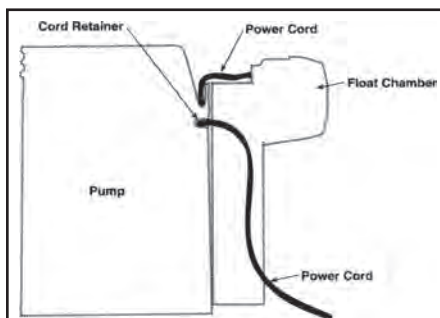
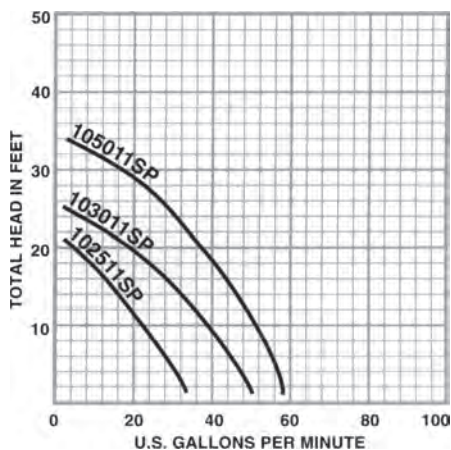

To insure proper on/off operation of the float switch, be sure the power cord is properly installed. See diagram above.

Prior to usage, power cord must be inserted into cord retainer.

1. With float chamber apart from the pump, insert cord into the cord retainer.
2. Install float chamber onto mounting guides on pump.
3. Take up slack of cord length so cord is taut.

Note: Model 102511SP has external ball float switch.

Note: Locke Code **S0063** has been discontinued, use **S0060** or **S0061**.

MATERIALS OF CONSTRUCTION:

Lower motor casing Aluminum
 Upper motor casing & pump jacket Reinforced Polypropylene
 Shaft Stainless Steel
 Shaft Seal Lip seal, Buna N
 Bearings Heavy Duty Ball
 Lower motor casing Polypropylene
 O-Rings Buna N
 Handle & Strainer Polypropylene
 Float (1-1/2 HP) Polypropylene
 Cable Neoprene

Locke#	Vendor#	H.P.	Amps	Weight	(RPM)	Voltage	Phase	Discharge	Cable Length
S0060	102511SP	1/4	4.4	7.0	3450	115	1	1 1/2"	10 ft.
S0061	103011SP	1/3	5.4	7.5					

Max. Fluid Temperature: 125° F (50° C) Continuous



SUMP PUMP 46GPM



Rugged cast iron construction, 3/10 HP continuous duty, thermal protected motor, pumps up to 46 gallons per minute. Pump will lift water up to 25' of vertical height. 10 ft. power cord. Large 1 1/2" discharge for high capacity pumping. Can be used as a utility pump by removing the float switch.

5030CVSP PERFORMANCE CHART

Total Dynamic Head (Ft)	0	5	10	15	20	25
Gallons Per Minute	46	36	30	25	12	1

Locke#

S0070 5030CVSP 3/10 HP Sump Pump



SUMP PUMP 40GPM



Tough thermoplastic construction, 1/3 HP continuous duty, thermal protected motor, pumps up to 40 gallons per minute. Pump will lift water up to 25' of vertical height. 10 ft. power cord. Large 1 1/2" discharge for high capacity pumping. Can be used as a utility pump by removing the float switch.

5033CVSP PERFORMANCE CHART

Total Dynamic Head (Ft)	0	5	10	15	20	25
Gallons Per Minute	40	34	28	22	12	2

Locke#

S0071 5033PVSP 1/3 HP Sump Pump

SUMP PUMPS

ALL-METAL SUBMERSIBLE PUMPS



A.Y. McDonald Mfg. Co.

K SERIES SUBMERSIBLE PUMPS

A.Y. McDonald offers a full line of 4" submersibles ranging from 1/3hp through 15hp. Our submersibles offer peak capacity performance in 5, 7, 10, 13, 18, 25, 35, 50, 75 & 90 GPM throughout the range of low to high leads.

All 4" submersibles are supplied w/ grounded leads meeting the National Electrical Code (NEC) specifications.

3 Wire single phase models include pump, motor, 48" leads, control box and check valve.

2 Wire single phase models include pump, motor, 48" leads, and check valve.

3 Wire three phase models include pump, motor, 48" leads, magnetic starter, heaters and check valve.

OUTPUT IN GALLONS PER HOUR - 1/2, 3/4, 1 HP;

Depth	25'	50'	75'	100'	125'	150'	175'	200'	225'	250'	275'	300'	325'	350'	375'	400'	425'
Discharge Pressure 0 P.S.I.																	
1/2 HP	995	950	865	790	720	635	540	445	325	160							
3/4 HP	1005	960	900	850	800	760	700	635	560	490	410	325	205				
1 HP	1020	975	940	895	860	820	775	725	680	640	590	535	475	420	325	240	120
Discharge Pressure 30 P.S.I.																	
1/2 HP	815	730	670	550	470	360											
3/4 HP	875	815	755	705	660	590	505	420	360	240							
1 HP	910	865	820	780	745	695	650	600	555	480	420	335	275				
Discharge Pressure 50 P.S.I.																	
1/2 HP	670	585	480	360	240												
3/4 HP	770	720	660	585	515	445	360	250	120								
1 HP	835	790	745	695	660	610	550	490	430	365	275	170					

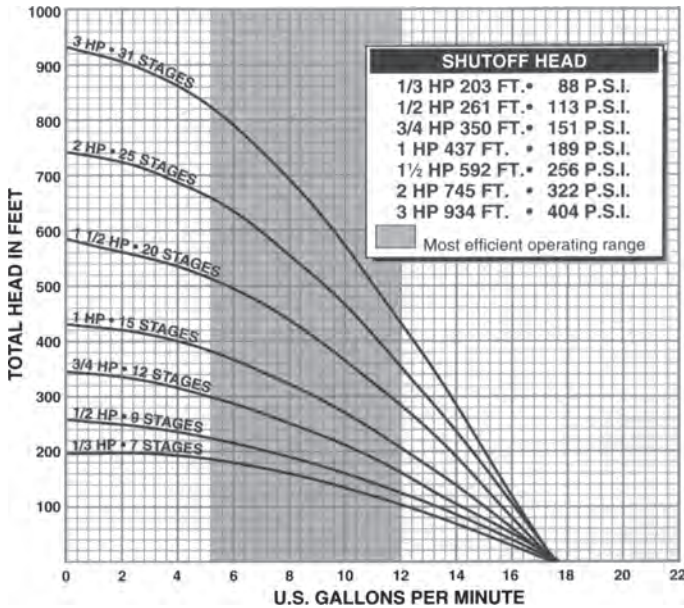

Features:

- Sizes 3hp to 3hp
- 1 piece replacement cartridge and completely field serviceable, easier to service for minimal down-time
- Powered by NEMA approved stainless steel motors with built-in lightning protection
- 2 wire models up to 1 1/2hp; 3 wire models up to 3 HP
- Rubber bearing - maximum abrasion resistance while maintaining shaft alignment
- Tough, lightweight acetal impellers; stainless steel coupling; Silicon bronze motor bracket & external check valve, non-corrosive screen and cable guard
- Available in 50 or 60 Hz.
- All K Series pumps have 1" discharge in external check valve

Locke#	Vendor#	HP	Stages	Volts	Discharge	Phase
S0175	21050K3	1/2	9	230	1"	1 Ph, 3 wire
S0176	21075K3	3/4	12	230	1"	1 Ph, 3 wire
S0184	21105K3	1	15	230	1"	1 Ph, 3 wire
S0159	21050K2	1/2	9	230	1"	1 Ph, 2 wire
S0160	21075K2	3/4	12	230	1"	1 Ph, 2 wire
S0161	21100K2	1	15	230	1"	1 Ph, 2 wire

THERMOPLASTIC SUBMERSIBLE PUMPS



A.Y. McDonald Mfg. Co.

K SERIES SUBMERSIBLE PUMPS

A.Y. McDonald offers a full line of 4" submersibles ranging from 1/3hp through 15hp. Our submersibles offer peak capacity performance in 5, 7, 10, 13, 18, 25, 35, 50, 75 & 90 GPM throughout the range of low to high leads.

All 4" submersibles are supplied w/ grounded leads meeting the National Electrical Code (NEC) specifications.

3 Wire single phase models include pump, motor, 48" leads, control box and check valve.

2 Wire single phase models include pump, motor, 48" leads, and check valve.

3 Wire three phase models include pump, motor, 48" leads, magnetic starter, heaters and check valve.

OUTPUT IN GALLONS PER HOUR - 1/2, 3/4, 1 HP;

Depth	25'	50'	75'	100'	125'	150'	175'	200'	225'	250'	275'	300'	325'	350'	375'	400'	425'
Discharge Pressure 0 P.S.I.																	
1/2 HP	995	950	865	790	720	635	540	445	325	160							
3/4 HP	1005	960	900	850	800	760	700	635	560	490	410	325	205				
1 HP	1020	975	940	895	860	820	775	725	680	640	590	535	475	420	325	240	120
Discharge Pressure 30 P.S.I.																	
1/2 HP	815	730	670	550	470	360											
3/4 HP	875	815	755	705	660	590	505	420	360	240							
1 HP	910	865	820	780	745	695	650	600	555	480	420	335	275				
Discharge Pressure 50 P.S.I.																	
1/2 HP	670	585	480	360	240												
3/4 HP	770	720	660	585	515	445	360	250	120								
1 HP	835	790	745	695	660	610	550	490	430	365	275	170					

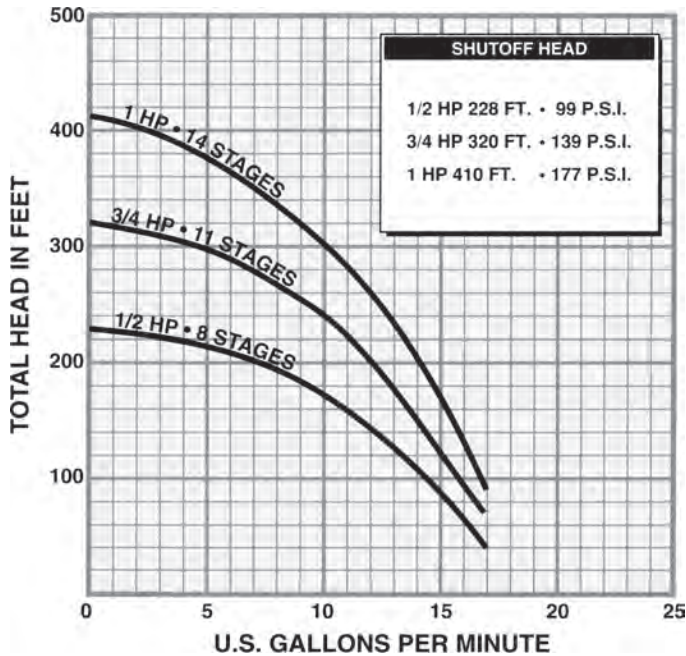

COST LESS!!
THESE THERMOPLASTIC SUBMERSIBLE PUMPS HAVE MUCH LOWER PRICES THAN THE ALL-METAL PUMPS!

Features:

- 3 Wire Models
- Sizes 1/2, 3/4" and 1 HP
- Acetal Impellers
- Injection molded glass filled Noryl motor
- Stainless Steel Pump Shell
- Polycarbonate Diffusers
- Stainless Steel Pump Shaft
- Glass Filled Noryl Check Valve Standard
- Powered by NEMA approved stainless steel motors with built-in lightning protection

Locke	Vendor	HP	Stages	Volts	Discharge	Phase
S0140	22050K3	1/2	8	230	1"	1 Ph,3 wire
S0141	22075K3	3/4	11	230	1"	1 Ph,3 wire
S0142	22100K3	1	14	230	1"	1 Ph,3 wire
S0143	22050K3A	1/2	8	115	1"	1 Ph,3 wire

PUMPS

SUBMERSIBLE PUMPS



A.Y. McDonald Mfg. Co.

M SERIES SUBMERSIBLE PUMPS

1 1/2 HP 230V 3 WIRE

3 Wire single phase models include pump, motor, 48" leads, control box and check valve.

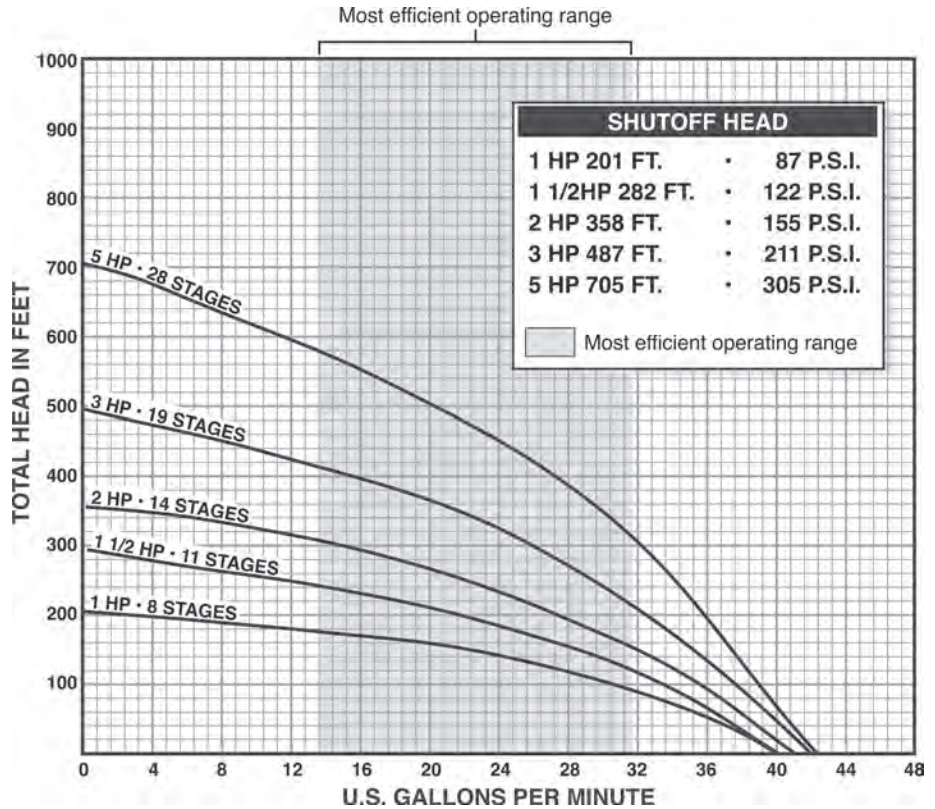
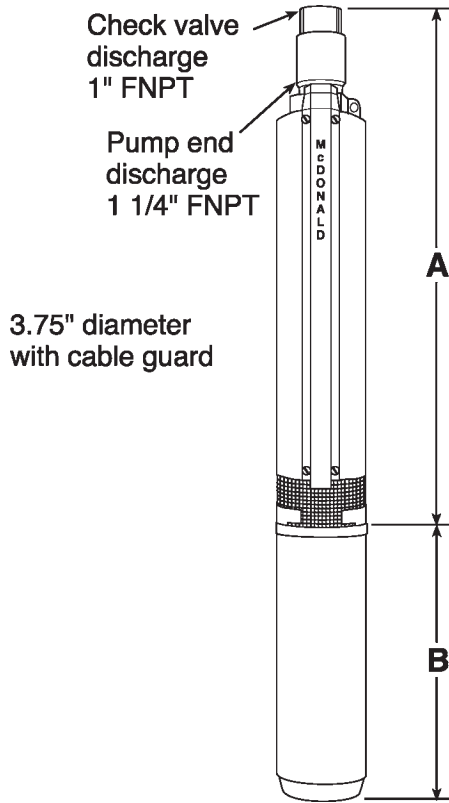

Locke#	MODEL NO.	HP	STAGES	VOLT	A	B	WT
S0185	21150M3	1 1/2 HP	11	230	19.21"	13.62"	40

OUTPUT IN GALLONS PER MINUTE

1 1/2 HP	PSI	DEPTH TO WATER																		
		50'	100'	150'	200'	250'	300'	350'	400'	450'	500'	550'	600'	650'	700'	750'	800'	850'	900'	
0	37.2	32.7	27.8	20.6	10.8															
30	30.8	25.1	16.9																	
50	25.6	17.7	7.0																	

A.Y. McDonald Mfg. Co.
 A.Y. McDonald offers a full line of sump pumps for home and light industrial applications. The following charts will assist you in choosing the pump that meets your needs.

PUMPS

SUBMERSIBLE PUMPS



A.Y. McDonald Mfg. Co.

V SERIES SUBMERSIBLE PUMPS 230V 3 WIRE** SINGLE PHASE

3 Wire single phase models include pump, motor, 48" leads, control box and check valve.

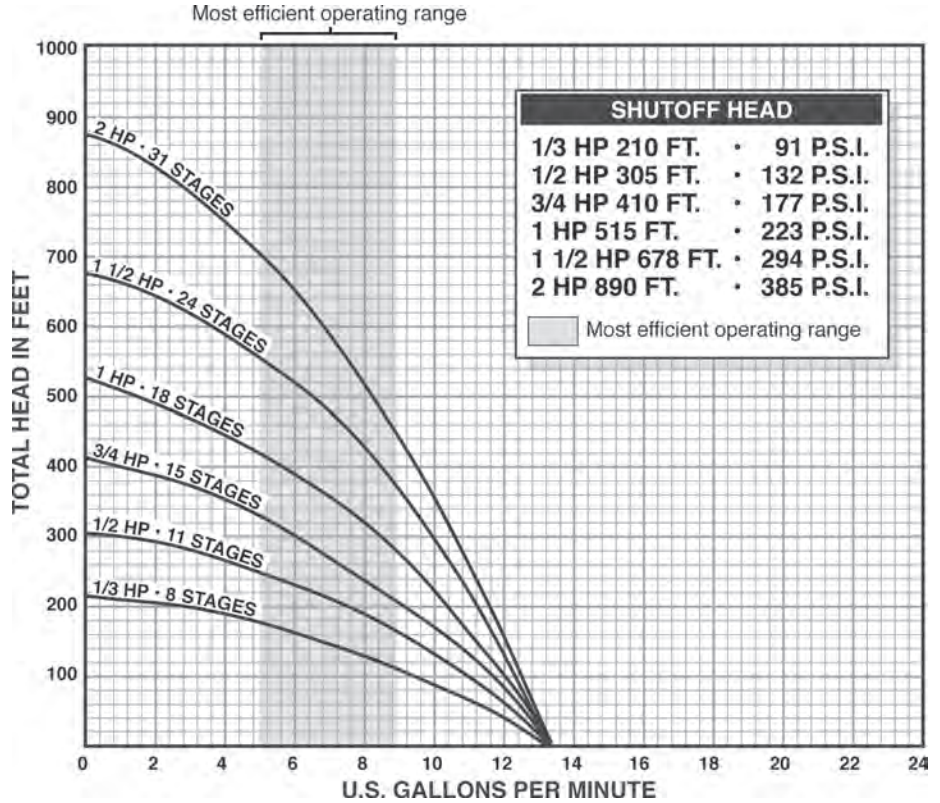
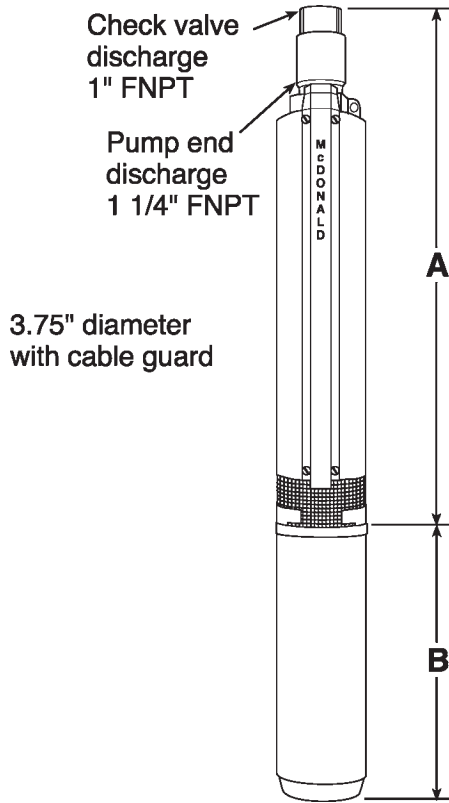

Locke#	MODEL NO.	HP	STAGES	VOLT	A	B	WT
S0200	21050V3	1/2	11	230	16.33"	9.53"	28
S0201	21100V3	1	18	230	21.77"	11.75"	37
S0202	21150V3	1 1/2	24	230	27.90"	13.62"	43

OUTPUT IN GALLONS PER MINUTE

DEPTH TO WATER

	PSI	DEPTH TO WATER																		
		25'	50'	75'	100'	125'	150'	175'	200'	225'	250'	275'								
1/2 HP	0	12.7	12.2	11.5	11.0	10.0	9.3	8.5	7.5	6.0	5.2	3.2								
	30	11.1	10.2	9.4	8.6	7.7	6.1	5.3	3.5	2.0										
	50	9.7	8.7	7.7	6.2	5.3	3.8	2.1												
1 HP	0	13.0	12.7	12.3	12.0	11.5	11.3	11.0	10.5	9.8	9.5	9.0	8.5	7.7	7.0	6.5	5.5	4.5	4.0	2.2
	30	12.2	11.7	11.5	11.2	10.7	10.0	9.7	9.2	8.7	7.8	7.2	6.7	5.7	4.6	4.1	3.3	1.9		
	50	11.7	11.3	10.8	10.1	9.8	9.3	8.8	7.9	7.3	6.8	5.7	4.8	4.3	3.4	2.0				
1 1/2 HP	0	13.2	12.3	11.7	11.3	10.7	10.0	9.3	8.5	7.5	6.7	5.5	4.2	3.2						
	30	12.2	11.5	11.2	10.5	9.8	9.2	8.3	7.3	6.5	5.3	3.9	3.0							
	50	11.5	11.2	10.5	9.8	9.2	8.3	7.3	6.5	5.3	4.0	1.1								

S PUMPS

JET PUMPS & SUMP PUMPS

A.Y. McDonald Mfg. Co. CONVERTIBLE JET PUMP

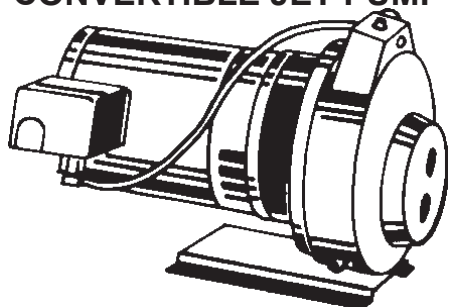

The McDonald convertible pump can be used in both shallow and deep well applications. Shallow well capacities to 1200 ghp, to depths over 120 feet. Pumps are powered by quality motors built to the latest NEMA specifications and employ extended, threaded, stainless steel shafts for positive alignment. Propeller material of either engineered thermoplastic or time proven bronze.

Locke#

S0164 8650 1/2 H.P. Jet Pump

S0163 8670 3/4 H.P. Jet Pump

CONVERTIBLE JET PUMP CHART

Water Depth/ Ft.	Gallons Per Hour	Shallow Well
15 Ft.	390	S164-8270 S147-851JP
25 Ft.	440	S163-8270 S154-652JP
Water Depth/ Ft.	Gallons Per Hour	Shallow Well and Deep Well Packages
5 Ft.	515	S0164-8250 S0147-551JP
15 Ft.	740	S0163-8270 S0154-652JP
25 Ft.	760	Special Ordered S0164-8250 S0147-551JP
50 Ft.	585	S0163-8270 S0154-652JP
60 Ft.	600	S0164-8250 S0147-551JP
75 Ft.	510	Special Ordered S0163-8270 S0154-652JP

JET TYPE WATER SYSTEMS include: Jet Pump, Tank, Air volume control, Well Seal, Ejector & Proper Size Plastic Pipe.

A.Y. McDonald Mfg. Co. SHALLOW WELL EJECTOR PACKAGES



Ejector package includes:
Ejector, Nozzle, Venturi, Gasket, Bolts, Washers and Cast Iron Casting.

Locke#

S0147 651JP 1/2 HP Ejector Package

S0154 652JP 3/4 HP Ejector Package

A.Y. McDonald Mfg. Co. DEEP WELL EJECTOR PACKAGES



Ejector package includes:
Ejector, Nozzle, Venturi, Gasket, Bolts, Washers, Foot Valve & Cast Iron Casting.

Locke#

S0148 508JP 1/2 HP Ejector Package

S0149 906JP 3/4 HP Ejector Package

S0155 509JP Ejector Package

A.Y. McDonald Mfg. Co. HEAT SHRINK SPLICE KIT

Locke#

S0168 6617-135 3 Wire with Ground

S0169 6617-136 2 Wire with Ground

PVC PUMP CABLE



Locke#

S0171 12/3 1000' Spool of PVC Cable

FLAT PVC PUMP CABLE



Locke#

S0206 10/3 PVC Pump Cable

S0207 12/3 PVC Pump Cable

A.Y. McDonald Mfg. Co. CAPACITORS

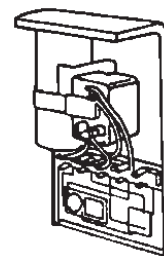

230 Volts

Locke#

S0166 6617-263 1/2 HP capacitor

S0167 6617-264 3/4 HP capacitor

A.Y. McDonald Mfg. Co. CHROME RELAY

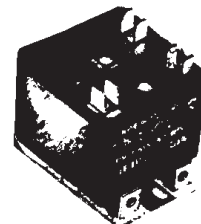

For Submersible Pump Applications. Chrome plating on the core and armature and the relatively small area of contact eliminates armature sticking due to organic contaminants which causes much relay failure. Universal break-off bracket on each relay. Simply snap off parts not needed. 3 adapters to convert push-on terminals to screw-on terminals are included.

Locke#

S0165 6617-269 Chrome Relay

A.Y. McDonald Mfg. Co. CONTROL BOXES ONLY

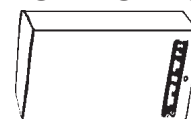

For Submersible Pumps

Locke#

S0144 6618-118 1/2 HP, 115 Volt

S0189 6618-119 1/2 HP, 230 Volt

S0190 6617-136 3/4 HP, 230 Volt

S0191 6617-111 1 HP, 230 Volt

S0193 6617-112 1 1/2 HP, 230 Volt

Check out our website
lockesupply.com
For directions to our
stores, credit services,
catalog PDFs and more.



CAST ALUMINUM WELL CAP



Locke#

S0068 VC600 6" Cast aluminum cap

S0069 VC800 8" Cast aluminum cap



BRASS PITLESS ADAPTER



0 - 100 psi.

Locke#

S0065 1" Brass Pitless Adapter

S0066 1 1/4" Brass Pitless Adapter



PRESSURE SWITCH



Captive nut on cover. Pressure switch pipe connection 1/4" NPT. Adjustment instructions are inside top cover. Contact points open on cut-out pressure. Points close on cut-in or pressure drop.

Locke#

S0179 MPS3050 On 30, Off 50

S0194 MPS2040 On 20, Off 40



LOW WATER CUT-OFF PRESSURE SWITCH



Shuts off at approximately 10 psi below cut-in pressure. Auto start - manual start or off lever

Locke#

S0195 MPSP43050 On 30, Off 50



TANK TEE

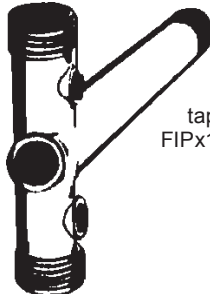

Solid brass construction. Short lets tapped with 2-1/4" taps. Top of cross tapped 1/2" FIP, 11" 3/4" FIPx1" MIP.

Locke#

S0198 BAT1002 Red Brass Tank Tee



SANITARY WELL SEALS

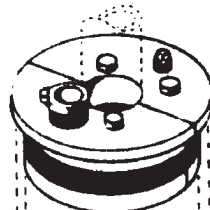

For shallow-well application. 2-piece cast iron construction. Rubber compression seal.

Locke# Well Size x Pipe Size

S0081 WS500100 5"x1" Well Seal

S0082 WS600100 6"x1" Well Seal



SANITARY WELL SEALS

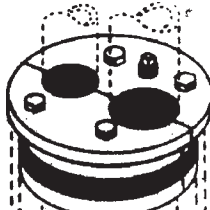

For Deep-Well Application. 2-piece cast iron construction. Rubber compression seal.

Locke# Well Size x Pipe

S0083 WS522510 5" x 1 1/4" x 1" Well Seal

S0084 WS622510 6" x 1 1/4" x 1" Well Seal

SANITARY WELL SEAL

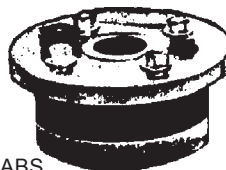

Hi-Impact ABS

Locke# Well x Pipe Size

S0076 501S 5" x 1" Hi-impact seal

S0077 601S 6" x 1" Hi-impact seal



PLASTIC FOOT VALVE



4 for 1 Foot Valve. Positive Sealing. Corrosion-proof. Strong -withstands pressure of over 200 psi. Self-cleaning. Full flow.

Locke#

S0100 3/4 - 1 1/2 Plastic Foot Valve



TORQUE ARRESTORS



Locke#

S0089 6814-175 4"-8" Arrestors



SNIFTER VALVE



Locke#

S0199 1/4" Snifter Valve



CHECK VALVE



For Submersible Pumps.

Locke#

S0075 1" MIP x 1" FIP Check Valve

S0074 1" FIP x 1 1/4" MIP Check Valve

Compare our Prices and Save!

S PUMPS

SUMP PUMPS & PUMP ACCESSORIES

PRESSURE GAUGES



1/4" MPT.

Locke#

S0180 100# Pressure Gauge, 2" face

S0181 0-100# Press.Gauge, 3 1/2" face

S0183 0-200# Pressure Gauge, 2" face

S0182 3/4" Female Hose thread x 1/4" Female thread - for attaching water test gauge to garden hose thread

-PASCO- LAZY HAND WATER TEST GAUGE



Regular pressure hand (shown at zero) pushes LAZY hand (shown at 240 lbs.) to peak operating or surge pressure point where it remains until you manually reset it. Excellent to determine if PIT valve is leaking from failure or if leaking is caused by surge or excessive pressures (gauge attached to boiler drain overnight) LAZY hand operates over entire gauge range. 3/4" FHT brass swivel connection

Locke#

S0192 1428 300# Pressure Gauge

*make money
The easy Way.
Buy right
and Save!!*

AMTROL^{INC.} CHAMPION[®]

PRE-PRESSURIZED WATER SYSTEM TANKS



Factory pressurized. Diaphragm separates air from water so no air volume control is needed. Compact size: greater drawdown. 5 year limited warranty. 100 PSIG Working Pressure.

Locke#

S0178 CH4202 20 Gal. Tank; 31 5/8" Ht, 15 5/8" Dia.

S0174 CH8003 32 Gal. Tank; 46 1/2" Ht, 15 5/8" Dia.

S0150 CH10050 44 Gal. Tank; 36" Height, 22" Dia.

S0151 CH12050 62 Gal. Tank; 46 3/4" Height, 22" Dia.

S0173 CH17002 86 Gal. Tank; 47 1/4" Height, 26" Dia.

S0156 CH22050 119 Gal. Tank; 61 7/8" Height, 26" Dia.

AMTROL^{INC.} HIGH PERFORMANCE SYSTEM

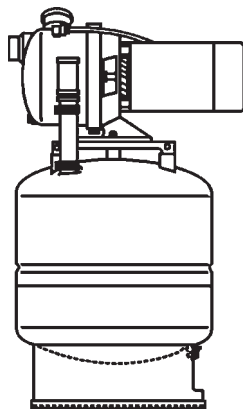

Tank pre-charge pressure is factory pre-set at 38 psig, & maximum working pressure is 100 psig. Voltage is 115/230. Note: Factory settings are for a water main pressure of 20 psig. To operate with lower water main pressure (min. of 5 psig required), pressure switch & tank Pre-charge must be adjusted.

Locke#

S0153 25 Fixture Pressure Boost

S0157 15 Fixture Pressure Boost

S0158 10 Fixture Pressure Boost

INDUSTRIES TOPP INCORPORATED

SUMP & SEWAGE PUMP BASINS & CHECK VALVES



Sump Pump Check Valve (1-1/4"x1-1/2") Pipe Hose Connection



Sewage Pump Check Valve (2x2) Pipe Hose Connection



Sewage Pump Basin (18x30) With (2x2) Split Cover

Locke#

S0030 18" x 30" Sewage Pump Basin

S0057 1/4" or 1/2" Sewage Pump Valve

S0059 2" Sump Pump Check Valve

S0027 Replacement Cover only for **S0030** Topp Only

Little Giant

"Your Solution Innovator"

DUPLEX PUMP CONTROLLER AND ALARM

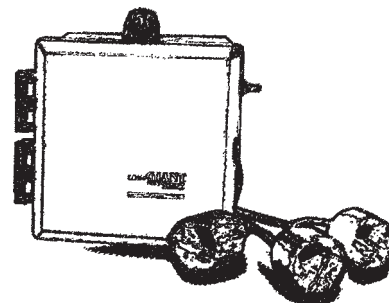

Controls two pumps running one or the other to prevent overheating. Visual and audible alarm.

Locke#

S0036 513258 NEMA-4X Duplex Alarm Systems Single Phase, 120/208/240V, 0-20 Amps, 20' Power Cords

Little Giant

"Your Solution Innovator"

INDOOR / OUTDOOR HI-WATER ALARM



Float switch with 15' cable. Alarm has red LED light, horn with silence switch & test button. 115V plug.

Locke#

S0054	101HW	Indoor Hi-Water Alarm with 6' Cord
S0064	303HWXT	Indoor/Outdoor Hi-Water Alarm with 15' Cord

Little Giant

"Your Solution Innovator"

AUTOMATIC "IN-PAN" CONDENSATE & WASTE WATER PUMP



Float - Operated, automatic 110V pump. Used to remove condensation from duct lines & other areas. Pumps up to 205 GPH. Designed for in-pan mounting. Float engages pump in 1.06" of water & shuts off at 1/2" of water. 6' power cord. 1/4" I.P. thread of discharge.

Locke#

L0927	550515	1/3 H.P. Jet Pump
--------------	--------	-------------------

SUMP PUMP CHECK VALVE

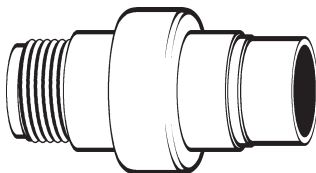

1 1/2" MPT inlet x Barb discharge. Durable thermoplastic body. Eliminates back flow. Sonic welded. Stainless Steel Clamps.

Locke#

S0197	SC150	1 1/2" Check Valve
--------------	-------	--------------------

Little Giant

"Your Solution Innovator"

DRAINOSAUR WATER REMOVAL SYSTEMS



S0040: TANK & PUMP

For applications where gravity drainage is impractical. Includes polypropylene tank (5 or 3 1/2 gallon). Also includes .3 HP automatic submersible sump pump with 8' power cord. Basin is IAPMO approved. 46 GPM max. flow rate. 18' max. head. Intermittent Liquid Temp. to 140F. Discharge: 1 1/2" FNPT. Housing: Epoxy coated cast iron. Cover: Polycarbonate. Volute: Polypropylene. Impeller: Nylon. Shaft Seal: Carbon/Ceramic. Electrical: 115V, 50/60 Hz, 9 amps.

Locke#

S0040	WRS-6	115 Volt 5 gallon Drainsaur
S0042	WRSC-6	115 Volt 3 1/2 gal. compact Drainsaur
S0043	599310	Switch For S0040 or S0042 Drainsaur Pumps

Little Giant

"Your Solution Innovator"

POTENT UTILITY PUMP SET

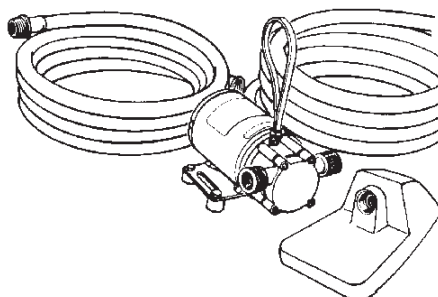

Lightweight & portable; sets include **one 6' hose**; carrying handle, 6' power cord & floor attachment for inlet hose; thermally protected; intermittent duty: 45 min. on, 45 min. off; inlet & outlet are both 3/8" FNPT & 3/4" garden hose thread.

Locke#

S0051	555122	360K Pump
S0063	555702	HRK-360S Repair Kit for S0051 Pump

Little Giant

"Your Solution Innovator"

WATER WIZARD



Makes water "vanish" to 1/8" of floor! Water wizard is completely portable & easy to use. Just attach a 1" hose or pipe, set into water at least 3/4" deep. Snap-off filter for easy cleaning. Equipped with 10' cord with 3 prong grounded plug. UL listed Garden Hose adapter included free. 1/8hp, 115volts. 350 GPH with 22' lift pipe. 1200 GPH with 1' lift pipe. 120 Volt.

Locke#

S0049	5-MSP/505000	1/8HP Pump
--------------	--------------	------------

Little Giant

"Your Solution Innovator"

MODEL RS-5 SWITCH

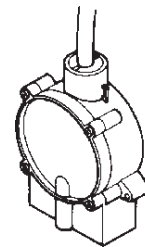

Converts any manual pump up through 1/2 HP, to automatic operation. Attaches easily to the back of the Little Giant Water Wizard. 115V, 10 amp switch has 10' power cord with 3-prong molded plug. "On" level: 7 3/8" (+/- 3/8"). "Off" level: 3/4" (+/- 3/8"). UL Listed.

Locke#

S0048	RS5/599008	Auto switch for S0049
--------------	------------	------------------------------

Little Giant

"Your Solution Innovator"

SUMP PUMP DISCHARGE KIT



24' Hose

Locke#

S0062	599301	1 1/4" Discharge Kit
--------------	--------	----------------------

SEWAGE PUMPS & TANKS

Little Giant

"Your Solution Innovator"

SIMPLEX PACKAGE



Features:

- 115 Volt, Sewage ejector pump 15' cord, 80 GPM @5'.
- 18"x30" polyethylene basin with structural foam 1-piece cover.
- Handles liquids & solid waste materials.
- Cover can be used as: 2" vent/ 3" discharge, 3" vent/ 2" discharge, or 2" vent/ 2" discharge.
- Sturdy roll-top design.
- .4 HP Automatic Sewage Ejector or Effluent pump.
- Full flow PVC check valve.

Locke#

S0031	9S-SMPXRT-K	Simplex Package with roll top polyethylene Basin pre-assembled; PIPE NOT INCLUDED
S0032	9S-CIA-RSF	The Eliminator® Sewage Ejector Pump: For use in the S0031 Simplex Package
S0033	RFSN-9 599117	Switch for S0031 - S0032

Little Giant

"Your Solution Innovator"

BIG JOHN SUMP PUMP

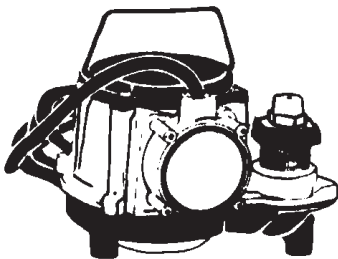

Provides high volume pumping capacity with a pressure actuated switch. Submersible cast iron housing. Polypropylene base, lifetime oil supply. Diaphragm operated switch. Non-clog pumping head & impeller. Screened intake: 1½" female NPT discharge. Thermal overload protector 8' cord, 8 amps: ¼ HP: 600 watts UL listed.

Locke#

S0050	6-CIA	.3HP Sump Pump
S0047	599300	Switch for S50

Little Giant

"Your Solution Innovator"

SEWAGE EJECTOR PUMP



Handles liquids and solid waste material up to 2" diameter. Cast iron pump housing with protective epoxy coating for corrosion resistance. Oil-filled motor housing for lifetime lubrication and rapid heat dissipation. Stainless steel screws, bolts and lifting ring. Mechanical seals (stainless steel spring, nitrile parts, carbon and ceramic faces) for long life and reliability. Secondary exclusion seal to help protect mechanical seal. Thermal overload protection. Permanent split capacitor design on single phase models. Capacitor and power cord isolated from oil-filled motor housing for ease of field maintenance. Dynamically balanced two-vane non-clogging impeller with pump-out vanes to protect seal.

Locke#

S0037	14S-CIM 514320	115v ½hp 20' cord 100gpm @10ft. 2" Discharge
S0038	16S-CIM 514620	230v 1hp 20' cord 160gpm @10ft. 3" Discharge
S0045	18S-CIM 520301	230v 1½hp 20' cord 160 gpm @ 10ft. 3" Discharge
S0039	20S-CIM 520100	230v 2hp 20' cord 205gpm @10ft. 3" Discharge

Little Giant

"Your Solution Innovator"

1/3HP PEDESTAL SUMP PUMP

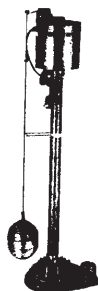

Has automatic overload protector with automatic reset. 1¼" Discharge pipe. Float activated switch. 2,820 GPH with 5' lift pipe. 115V, 60 Hz, 5.8 amps. Polypropylene base & strainer.

Locke#

S0025	VS-P2800	3hp pedestal pump
S0046	950341	Switch for S25 Pump

Little Giant

"Your Solution Innovator"

ELIMINATOR WASTE WATER & SEWAGE PUMP

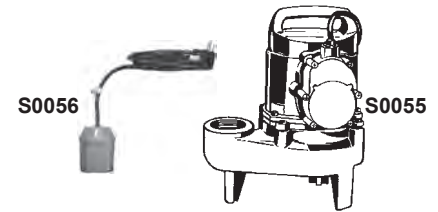

The Eliminators - USA Series - include pumps for use in residential, commercial, industrial & agricultural applications with light to medium transfer demands. For de-watering, effluent waste, wastewater & sewage handling where such materials must be moved upward from a collection area to sewer or septic lines, or drainage areas, the Eliminators are an ideal solution.

Handles liquids & solid waste materials up to 2" dia., ½ H.P. motor, 2" FNPT discharge. Glass-filled polypropylene electrical case, & Auto float switch (RFS-10) for automatic operation.

Locke#

S0055	10S-CIA-RFS	Sewage pump only, ½ HP 2" discharge
S0056	RFSN-6/599118	Float Switch with 10' Cord for S55

Little Giant

"Your Solution Innovator"

WIDE ANGLE FLOAT SWITCH



Applications: Sumps, Holding Tanks, Conversion of non-automatic pumps, Replacement for diaphragm or probe type controls

Features: Heavy duty contacts, Totally self-contained pump switch - no control panel required, SA listed for use in water and sewage, UL certified.

Locke#

S0033	RFSN-9-599117	Switch for S0031 and S0032 pumps
S0034	RFSN-10-599210	Switch for S0055 pump
S0035	RFSN-16-599211	Switch for S0037 and S0038 pumps
S0044	RFSN-20-599318	Switch for S0045 and S0039 pumps

RAIN BIRD MODULAR 8 STATION CONTROLLER



Flexible, reliable, and easy to use 8 station indoor or outdoor sprinkler timer. Expands up to 32 stations with expansion module. A member of the popular ESP family of controllers, the ESP-LX Modular can fit the specification from a residential installation to a high-end commercial installation. The large display and intuitive programming sequence make this the most user-friendly controller in its class. The spacious cabinet and quickconnect terminal locations make installation a snap. Features like the Contractor Default™ program with restore timer and hotswappable modules (that's right, no need to power down!) make service calls more efficient and earn you more money by taking less time!

Install it, set the program and walk away with confidence. No other controller matches the ESP-LX Modular for flexibility, reliability and ease of use.

Flexible Programming Options Include:

- Cycle+Soak™
- Programmable Valve Delay
- Sensor Override by Station
- Master Valve by Station
- Calendar Day Off
- Total Program and Valve Run Times

Locke#

S0424 ESP-LX-M Modular Outdoor

RAIN BIRD ESP-LX MODULAR EXPANSION MODULE



8 station expansion module for ESP-LX Modular Series controllers. Hot-swappable module adds an additional 8 stations up to 32 stations maximum.

Locke#

S0423 ESP-LX-MSM8 8 Station Output Module

RAIN BIRD MODULAR 4 STATION CONTROLLER



4 station modular controller with three independent programs, easily expands up to 13 stations with the addition of plug-in modules.

Rain Bird® ESP-Modular Controllers are simple to program, making it easy to monitor and adjust watering schedules based on your landscape's diverse watering needs. It improves upon Rain Bird's already easy-to-use ESP style of programming with a large, easy to read display and intuitive programming sequence, making this the most user-friendly irrigation controller in its class. Another example of Rain Bird's legendary reliability, the ESP Modular offers industry-leading surge protection, temperature tolerance and rugged construction. The spacious cabinet and terminal locations make installation and wire-up a snap.

- Multiple programs give you the flexibility to accommodate the diverse watering needs of different plants and those areas of your lawn and garden that get more sun or shade, saving you water and money.
- Each program can have multiple start times, allowing you the flexibility to run programs several times a day for shorter lengths of time, helping you maintain a healthier lawn and garden.
- The modular design makes it easy to expand the controller's capabilities
- The water budget feature allows you to easily increase or decrease watering schedules

Locke#

S0465 ESP4M 4 Station Base Unit Outdoor Mount

S0466 ESP4Mi 4 Station Base Unit Indoor Mount

RAIN BIRD ESP MODULAR- EXPANSION MODULE



3-station expansion module for ESP-Modular Controllers. Expand your ESP4M Controller from a 4 station base model up to 13 stations with this 3 station hot-swappable module, which can be added without powering down the controller.

Locke#

S0467 ESPSM3 3 Station Module

RAIN BIRD SPX FLEX SWING PIPE



Use Rain Bird Swing Pipe with Spiral Barb Fittings as a flexible swing assembly for sprays and rotors.

Locke#

S0402 Spxflex100 100' Swing Pipe

RAIN BIRD XERI BLACK STRIPE TUBING



Designed for use with all drip systems. Constructed from high quality, UV resistant resin blend materials, our tubing is rated up to 60 psi.

- Can be installed at or below grade
- Compatible with Easy Fit Compression Fittings or standard 710 compression fittings

Locke#

S0298 XBS500P purple stripe, 500'

RAIN BIRD RAIN BIRD XF™ SERIES DRIPLINE



The most flexible, kink-resistant tubing available. It accepts 17mm insert fittings, XF™ Series Dripline Insert Fittings, Rain Bird Easy-Fit compression fittings and LOC fittings.

- Bend radius for XF™ dripline is 3".

Locke#

S0470 XFD0912250 .9 Gph PC Emmiter 12" Spacing 250'

RAIN BIRD LANDSCAPE DRIPLINE

Pressure compensating inline emitter tubing, delivers unmatched clog-resistance for long term reliability. Ideal for ground cover, mixed plantings, slope plantings and hedge rows.

Locke#

S0299 LD-06-18-500 0.6 GPH 18" spacing 500ft.

S | PUMPS

RAIN BIRD PEB SERIES IRRIGATION VALVE



Industrial-strength glass-filled nylon globe valve for **commercial** irrigation applications. The PEB Series is our most durable plastic valve.

- Slow closing to prevent water hammer and system damage.
- Low flow capability.
- Flow control handle adjusts water flows as needed.
- One-piece solenoid design with captured plunger and spring for easy servicing. Prevents loss of parts during field service.
- Manual external bleed permits flushing debris from the system.

Locke#

S0407	100PEB 1" Electric Valve 24v
S0409	150PEB 1½" Electric Valve 24v
S0419	200PEB 2" Electric Valve 24v

RAIN BIRD PGA SERIES IRRIGATION VALVE



Plastic globe/angle valve for **residential and light commercial** applications, offering versatility at an affordable price.

- Globe and angle configuration for flexibility in design and installation.
- Rugged PVC construction.
- Double-filtered pilot flow to resist debris and clogging of solenoid ports.
- Slow closing to prevent water hammer and system damage.
- One-piece solenoid design with captured plunger and spring for easy servicing. Prevents loss of parts during field service.
- Non-rising flow control handle adjusts water flow as needed.

Locke#

S0408	100PGA 1" Elect Valve Globe Angle Configurat
S0410	150PGA 1½" Elect Valve Globe Angle Configurat
S0420	200PGA 2" Electric Valve Globe Angle Configurat

RAIN BIRD JTV JAR TOP VALVE



Provides versatility, reliability, affordability and ease of service for **residential and light commercial** applications. The threaded bonnet design allows for tool-free access and maintenance, eliminating the need to remove and replace multiple screws.

- Double-filtered pilot flow for maximum reliability
- Balanced-pressure diaphragm for long life
- Buna-N diaphragm with self-cleaning 90-mesh (200 micron) pilot water filter and stainless steel spring
- Energy efficient, encapsulated solenoid with captured plunger
- Operates in low-flow and Xerigation® applications when the RBY filter is installed upstream

Locke#

S0436	100JTVSS 1" Elect Valve Remote Control Slip X Slip
--------------	--

RAIN BIRD DVF SERIES SPRINKLER VALVE



Economical irrigation valve for **residential and light commercial** applications where flow control is required.

- Double-filtered pilot-flow design for maximum reliability.
- Balanced-pressure diaphragm for long life.
- Energy-efficient, encapsulated solenoid with captured plunger and 90-mesh (200 micron) solenoid filter.
- Buna-N diaphragm with self-cleaning 90 mesh (200 micron) pilot water filter and captive spring.
- Operates in low-flow and Xerigation® applications when the RBY filter is installed upstream.

Locke#

S0434	100DVFSS 1" Elect Valve Remote Control Slip x Slip
--------------	--

RAIN BIRD DV SERIES VALVE



Economical irrigation valve for **residential and light commercial** applications.

- Double-filtered pilot-flow design for maximum reliability.
- Energy-efficient, encapsulated solenoid with captured plunger and 90-mesh (200 micron) solenoid filter.
- Operates in low-flow and Xerigation® applications when the RBY filter is installed upstream.

Locke#

S0435	100DVSS 1" Electric Valve Remote Control Slip x Slip
--------------	--

RAIN BIRD 5004 SERIES ROTOR



Mid-range rotor offers great durability. Part or Full Circle Spray, Pressure in stem Regulator and Seal-A-Matic protection. Includes Nozzle Tree.

- Heavy-duty cover assembly for extra durability
- Heavier-duty retract spring assures positive pop-down
- Curtain™ Nozzles (Angle of Trajectory 25°) provides 25 to 50' distance of throw
- Top-adjust arc adjustment requiring only a flat-blade screwdriver

Locke#

S0454	5004FC 4" Full Circle Rotor Pop-Up Sprinkler
S0455	5004PC 4' Part/Reverse Part Circle Rotor Popup
S0456	5004PLPC 4' Plus series Part/Reverse Part Circle Rotor Popup

RAIN BIRD 5006 SERIES ROTOR

The 5006 Plus Series mid-range rotor offers great durability and the superiority of Stream Control™ Technology. Available with Part(40-360 degrees adjustable) or Full (360 degrees only) Circle Spray, and Seal-A-Matic protection. Includes Nozzle Tree.

Locke#

S0472	5006PLPC Plus Part Circle
--------------	---------------------------



1800 SERIES SPRAY HEAD



4, 6 or 12" body height spray heads, first-rate quality built in for reliable operation and long life. Superior components and first rate design features make this the spray head of choice for a variety of applications.

- Precision flush at pop-down clears debris, assuring positive stem retraction in all soil types.
- Strong stainless steel spring provides reliable stem retraction.
- Two piece ratchet mechanism on all models allows easy nozzle pattern alignment without tools.
- Pre-installed orange 1800 Pop-Top™ flush plug blocks debris from entering after flushing. Allows for easy nozzle installation.
- Constructed of plastic and stainless steel parts, assuring long life.

Locke#

S0451	1804R	Spray Head Body Only	4" Pop-Up Height
S0405	1806	Spray Head Body Only	6" Pop-Up Height
S0406	1812	Spray Head Body Only	12" Pop-Up Height



1800 PRS SPRAY HEAD



4, 6, or 12" Spray head with patented PRS pressure regulator built into the stem. Designed for areas with high and/or widely fluctuating water pressures, and has all 1800 Series features, plus:

- Patented PRS pressure regulator built into the stem. No parts to be installed at the site. Saves time.
- Maintains constant outlet pressure at 30 psi. Spray heads and nozzles perform best at 30 psi.
- Ends misting and fogging caused by high pressure. Stops water waste
- "PRS" stamped on cap for easy identification and maintenance.

Locke#

S0412	1804PRS	Spray Head Body Only With PRS 4" Pop-Up
S0415	1806PRS	Spray Head Body Only With PRS 6" Pop-Up
S0417	1812PRS	Spray Head Body Only With PRS 12" Pop-Up



1800 SAM-PRS SPRAY HEAD



4 or 12" top-of-the-line spray head that includes all the SAM and PRS Features.

- Meets the needs of all spray areas, regardless of changing elevation or water pressure.
- Incorporates all 1800 Series SAM and PRS features.
- "SAM-PRS" stamped on cap for easy identification and maintenance.

Locke#

S0414	1804SAMPRS	Spray head only with SAM/PRS 4" Popup
S0418	1812SAMPRS	Spray head only with SAM/PRS 12" Popup



1800 EXTENSION



Extends all Rain Bird spray head models an additional 6½" in height.

- UV-resistant thermoplastic construction for long life.
- Fits all Rain Bird spray heads and nozzles. Exception: Cannot be used with bubblers.
- Easily installed without any tools.
- Maximum two extensions per sprinkler.

Locke#

S0411	A44500	6" Stem Extension
--------------	--------	-------------------



3RC QUICK COUPLER



Industrial-strength brass quick-coupling valves for convenient water access. ¾" 1 piece brass body with yellow rubber non-locking rubber cover.

- Red brass construction for long life and rugged performance.
- Strong corrosion-resistant stainless steel spring prevents leakage.

Locke#

S0422	3RC	¾" Quick Coupling Valve Rubber Cover
--------------	-----	--------------------------------------



VALVE KEYS



Key threads into top of quick-coupling valve to provide water access.

Locke#

S0421	33DK	¾" NPT Double Lug Valve Key
--------------	------	-----------------------------





1400 SERIES BUBBLER NOZZLES



Nozzle for irrigating tree, shrub and flower areas where pressure compensation is required with .5 or 1 GPM.

- Low flow rates allow water to be absorbed as needed.
- Reduces runoff.
- Flow will not fluctuate at pressures between 20 and 90 psi.
- Shipped with special bubbler filter screen for easy installation and resistance to debris.

Locke#

S0403	1402	.5 Gpm Pressure Compensating Bubbler
S0404	1404	1 gpm Pressure Compensating Bubbler



U SERIES NOZZLES



Nozzles with ¼, half, full, and third circle arc spray. *Full Circle not a Dual Spray*. The patented U-Series nozzle is the first plastic nozzle with a second orifice for close-in watering and more uniform water distribution. Its unique patented design cuts watering times, saves water and money, and reduces waste. U-Series nozzles fit all Rain Bird sprinklers and shrub adapters and can be used with new and improved PCS screens.

- Fine mesh screen protects bottom orifice from debris.
- Uses 30% less water.

Locke#

S0425	U10F	10' Radius Full Circle
S0426	U10H	10' Radius Half Circle
S0427	U10Q	10' Radius ¼ Circle
S0428	U12F	12' Radius Full Circle
S0429	U12H	12' Radius Half Circle
S0430	U12Q	12' Radius ¼ Circle
S0431	U15F	15' Radius Full Circle
S0432	U15H	15' Radius Half Circle
S0433	U15Q	15' Radius ¼ Circle



MPR SERIES NOZZLES



Matched Precipitation Rate (MPR) nozzles allow sprinklers with various arcs and radii to be mixed on the same circuit. Available in ¼, ½, & full circle nozzles.

- 5 Series nozzles meet small-area shrub or turf requirements.
- 8 Series nozzles have a lower water flow which allows more spray heads per zone.
- 1800 Series white filter (.035" x .035") screens (shipped with nozzles) maintain precise radius adjustment and prevent clogging. (5 and 8 Series nozzles are shipped with blue fine-mesh (.02" x .02") filter screens.)
- Stainless steel adjustment screw to adjust flow and radius.

Locke#

S0457	5H	5' Radius ½ Circle
S0458	5Q	5' Radius ¼ Circle
S0460	8F	8' Radius Full Circle
S0461	8H	8' Radius ½ Circle
S0462	8Q	8' Radius ¼ Circle
S0464	9SST	15' Radius Side Strip 9' X 18'
S0437	10F	10' Radius Full Circle
S0438	10H	10' Radius ½ Circle
S0439	10Q	10' Radius ¼ Circle
S0441	12F	12' Radius Full Circle
S0442	12H	12' Radius ½ Circle
S0443	12Q	12' Radius ¼ Circle
S0445	15EST	15' Radius End Strip
S0446	15F	15' Radius Full Circle
S0447	15H	15' Radius ½ Circle
S0448	15Q	15' Radius ¼ Circle
S0449	15SST	15' Radius Side Strip

VAN SERIES VARIABLE ARC NOZZLES

Adjustable up to 4,6,8,10,12,15, or 18 feet nozzles for all standard and irregular-shaped turf and shrub areas

Locke#

S0453	4VAN	4' Radius Variable Arc
S0459	6VAN	6' Radius Variable Arc
S0463	8VAN	8' Radius Variable Arc
S0440	10VAN	10' Radius Variable Arc
S0444	12VAN	12' Radius Variable Arc (MPR)
S0450	15VAN	15' Radius Variable Arc (MPR)
S0452	18VAN	18' Radius Variable Arc (MPR)



PLASTIC SHRUB ADAPTER



Plastic model which attaches nozzle to riser to irrigate ground cover and shrub areas.

- Adapts Rain Bird nozzles to 1/2" MPT risers.
- Accepts 1800 Series filter screen (shipped with nozzle) and PCS Series screens.
- Fine top threads accept all Rain Bird nozzles

Locke#

S0469	PA8S	Plastic shrub adapter
--------------	------	-----------------------



STANDARD VALVE BOX



Length: 21.8 inches
Width: 16.6 inches
Height: 12.0 inches
Standard (Body & Green Lid)

Locke#

R1028	VBSTD	Valve Box
--------------	-------	-----------



RETROFIT PRESSURE REGULATOR



Provides convenient 30 psi pressure regulation at the riser for any 1/2" FPT emission device or compression adapter.

Locke#

S0473	PRS05030	Retrofit Pressure Regulator
--------------	----------	-----------------------------

RAIN BIRD
**POP-UP IMPULSE
SPRINKLERS**

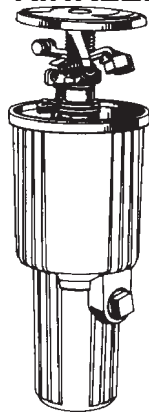

- #1 pop-up impulse sprinkler.
- Water Saver brass weighted PJTM spray guide arm controls stream, prevents side splash onto buildings and walkways.
- Patented, pressure-activated wiper seal assures reliable pop-up and pop-down.
- Diffuser screw breaks water into smaller droplets for uniform watering.
- 1/2" female connection at side or bottom.

LG-3 Low Gallonage

- Low gallonage flow for watering at a uniform, steady rate of 2.3 gallons per minute.
- Permits more heads per valve. Especially recommended for low pressure areas.
- Spacing from 25 to 43 feet apart.

Locke#

S0210	LG-3	Low Pop-up Impulse Sprinkler
--------------	------	------------------------------

RAIN BIRD
1300 FLOWER BUBBLER

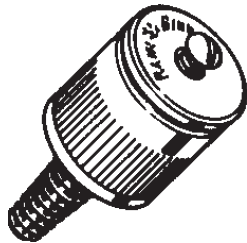

- Full circle pattern only.
- Flow adjustment screw regulates water flow for spacing 1 to 3 feet apart.
- Filter screen included.
- 1/2" female pipe connection.
- Discharges 1.4 GPM at 20 psi.

Locke#

S0251	1300	Flower Bubbler
--------------	------	----------------

RAIN BIRD
**25PJDA-C DELUXE
BRASS IMPULSE
SPRINKLER**

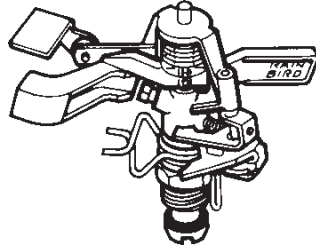

- The #1 selling brass sprinkler.
- Brass, bronze and stainless steel construction lasts longer than competitor's zinc sprinklers.
- Adjustable deflector flap adjusts stream length from 20-foot to 41- foot radius.
- Diffuser screw breaks water into smaller water droplets for uniform watering.
- Water Saver white-bronze PJ™ spray guide arm controls stream, prevents side splash onto buildings and walkways.
- Full and part circle coverage, with infinite pattern adjustment.
- 1/2" male pipe thread connection.
- 50 feet maximum spacing - high gallonage output.

Locke#

S0217	25PJDA -C	Deluxe Brass
--------------	-----------	--------------

RAIN BIRD
**P5-R BLACKBIRD™
IMPACT SPRINKLER**

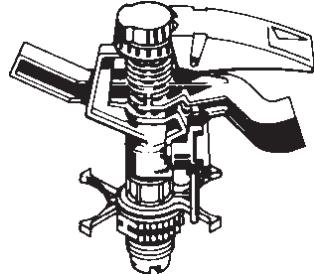

- The #1 selling plastic impulse sprinkler.
- Infinite 0° to 360° spray pattern
- Adjustable 20' to 41' stream length
- Waters a huge 82' diameter area
- 5gpm output at 50psi
- Exclusive grooved deflector provides an even spray at all distances.
- Water Saver PJ™ spray guide arm controls stream, prevents side splash onto buildings and walkways.
- 1/2" male pipe connection.

Locke#

S0220	P5-R	Blackbird™
--------------	------	------------

RAIN BIRD
**A-17 SERIES SHRUBBERY
SPRAY HEADS**



- Adjustment screw regulates distance of throw for spacing from 6 to 15 feet apart.
- Matched Flow Rate nozzles assure uniform watering when different patterns are mixed on the same circuit.
- Mount above ground on a riser tall enough to clear shrubs and tall plantings.
- 1/2" female pipe connection.

Locke#

S0245	A17-F	Full
S0246	A17-H	Half
S0247	A17-Q	1/4
S0249	A17-CST	Center Strip

RAIN BIRD
**A-17-AP-C SHRUBBERY
SPRAY HEADS WITH
ADJUSTABLE PATTERN
NOZZLE**



- Adjustable Pattern Nozzle waters any part of a circle from 0° to 330°. Easy to adjust for complex watering needs - no tools needed.
- The Adjustable Pattern nozzle distributes water evenly regardless of pattern set and is compatible with other Rain Bird matched flow rate nozzles.

Locke#

S0250	A17-AP-C	Adjust. Pattern
--------------	----------	-----------------

S PUMPS



SURE POP™ 600 SERIES 4" POP-UP SPRINKLER



- Full 4 inch pop-up clear taller grass and other obstacles.
- Patented stem cleaner keeps debris out, prevents loss from flow-by, and ensures popup at low water pressure.
- Reliable, low-pressure operation.
- Low flow for water conservation.
- Matched Flow Rate nozzles assure uniform watering when different patterns are mixed on the same circuit.
- Easy to remove filter screen - just below the nozzle.
- Adjustable distance of throw for spacing from 6 to 15 feet apart.

Locke#

S0219	SP40-AP	4" Adjustable
S0225	SP40-F	4" Full
S0226	SP40-H	4" Half
S0227	SP40-Q	4" ¼
S0228	SP40-SQ	4" Square
S0229	SP40-EST	4" End Strip
S0230	SP40-CST	4" Center Strip
S0231	SP40-SST	4" Side Strip



SURE POP™ 600 SERIES 2½" POP-UP SPRINKLER



- Full 2½" pop-up clears grasses others won't.
- Patented stem cleaner keeps debris out, prevents loss from flowby, and ensures pop-up at low water pressure.
- Reliable, low-pressure operation.
- Low flow for water conservation.
- Matched Flow Rate nozzles assure uniform watering when different patterns are mixed on the same circuit.
- Easy to remove filter screen - just below the nozzle.
- Adjustable distance of throw for spacing from 6 to 15 feet apart.

Locke#

S0235	SP25-F	2½" Full
S0236	SP25-H	2½" Half
S0238	SP25-SQ	2½" Square



TDR-2 LAWN BIRD™ CLOSED CASE ROTOR

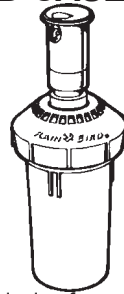

- Closed case design for superior performance in sandy soil, heavy turf and dirty water.
- Water lubricated drive mechanism for quiet operation.
- Vandal-resistant Memory Arc™ prevents tampering with pattern you set.
- Pops up 3½" to water, pops down for mowing and safety.
- Easy to change nozzles for low and medium gallonage watering.
- Full and part circle watering - just push and turn to set pattern - no tools required.
- Uniform watering for medium to large areas.

Locke#

S0216	42SA	Closed Case Rotor
--------------	------	-------------------



32SA GEAR DRIVEN ROTOR



The 32SA Simple Adjust Rotor is an intuitive short to mid-range ½" gear-drive rotor for residential applications.

Features and Benefits:

- 19' - 32' distance of throw.
- Top-adjust arc adjustment requiring only a screwdriver.
- This rotor comes with a pre-installed 3.0 Rain Curtain nozzle.
- Water-lubricated gear-driven design for durable, reliable operation.
- 40 - 360° Part-circle arc rotation and reversing full-circle rotation in one.
- True 4" (10,2cm) pop-up (measured from center of nozzle) Quick Check Arc/Fast Forward.
- Self-adjusting stator does not require replacement when changing nozzles.
- Easily removable filter screen.
- Arc setting factory preset at 180° for installation convenience.
- ½" NPT female bottom threaded inlet

Locke#

S0218	32SA	Gear Driven rotor
--------------	------	-------------------



AUTOMATIC ANTI-SIPHON VALVES

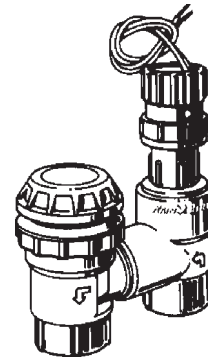

- Patented design with anti-siphon vacuum breaker prevents back-flow.
- Internal filter screen keeps dirt and debris out of piston.
- Spray-free internal bleed.
- Meets IAPMO-UPC (Uniform Plumbing Code) requirements for city water hookup.
- On-off manual and flow adjustment control.
- Electric, works with any standard 24 volt sprinkler timer.
- Easy actuator removal for servicing.

Locke#

S0266	APAS-100-P	1" FPT Valve
--------------	------------	--------------



ELECTRIC IN-LINE VALVES

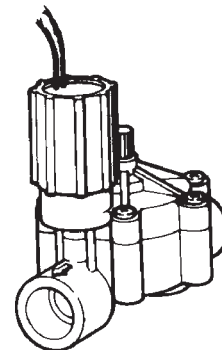

- In-line design minimizes pressure loss.
- Reliable non-clogging design for below-ground installation.
- Reverse-flow design with balanced diaphragm for reliability and durability.
- Works with any standard 24 volt sprinkler timer.

Locke#

S0260	CP-075	¾" FPT In-Line Valve
S0261	CP-100	1" FPT In-Line Valve
S0280	SRK-CP	Replacement Solenoid Kit For CP Valves
S0281	DRK-CP	Diaphragm Replacement Kit For CP Valves

SPRINKLER VALVES, PARTS AND FITTINGS

RAIN BIRD EZ SPRINKLER HEAD INSTALLATION

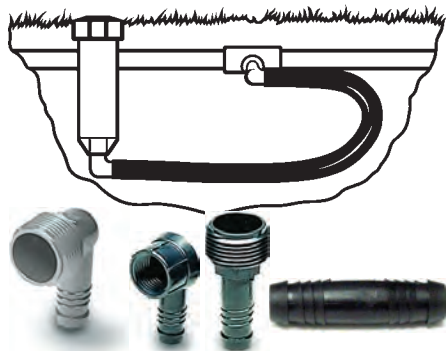

- Flexible tubing for easy installation.
- Prevents broken pipe and risers.
- Simplifies replacement of sprinkler heads of different heights.
- Allows fine-tuning of sprinkler head location during installation.
- Barb fittings (no gluing or clamps).

Locke#

S0290	EZP-2	24" Length Pipe
S0292	EZE-10	1/2" MPT Elbow
S0291	SB-CPLG	1/2" barb coupling
S0296	SBA-050	1/2" MIP x 1/2" Barb adapter
S0293	SBE-075	3/4" MIP x 1/2" Barb elbow
S0297	SBFE-050	1/2" FIP x 1/2" Barb elbow

RAIN BIRD 1/2" SPIRAL BARB TEE



- Easy twist-in insertion – no glue or clamps needed for installation.

Operating Pressure: Up to 80 psi
Temperature: Up to 110° F

Locke#

S0298	SB-TEE	1/2" barb x 1/2" barb x 1/2" barb tee
--------------	--------	---------------------------------------

Orbit | Irrigation CUT-OFF RISERS



- Molded, Polyethylene material
- Riser can be cut to desired length
- Not for use under continuous pressure

Locke#

S0294	1/2" x 6" Cut-off Riser
S0295	1/2" x 3/4" x 6" Cut-off Riser

KING INNOVATION® WATERPROOF WIRE CONNECTOR

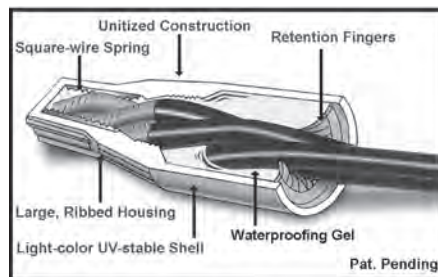

Locke# Size

S0302	20111	30 Volt	TAN
		Waterproof Wire Connector	
S0303	10666	600 Volt	BLUE
		Waterproof Wire Connector	
S0304	61135	600 Volt	Black/White
		Waterproof wire connector #22-#8	



SPRINKLER CABLE

18/8 sprinkler cable, 1000' spool.

Locke#

P2234	18/8 Sprinkler Cable
--------------	----------------------

*We appreciate
your
Business!*

KING INNOVATION® DRAINS

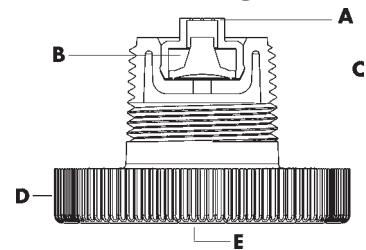

- A. Self-cleaning Dirt Arrestor Screen**
The raised screen prevents clogging of drain due to sediment and/or contaminants.
- B. Patented Pressure Sensitive Valve**
Releases water slowly at root level.
- C. Patented Backflow Check**
Eliminates potential freeze damage and backflow contamination by preventing water from re-entering system.
- D. Ergonomic, Non-Corrosive Housing**
Injection molded with high impact polymer to ensure lifetime protection.
- E. Broad Dispersing Pad**
Keeps roots and soil from penetrating, minimizing the need for sumps.

Locke# Size

S0300	GF 22163	1/2" MPT Lateral Line King Drain
--------------	----------	-------------------------------------



3/4" STRAIGHT VALVE WITH RISING SWIVEL



Locke#

M1513	100RS-075	3/4" Straight Valve, Rising Swivel, Red Brass
--------------	-----------	--



SPRINKLER CONTROL VALVE KEYS



Locke#

T0223	30-30	30" Sprinkler Control Valve Key
T0224	30-54	54" Sprinkler Control Valve Key