

BRASS FITTINGS



BRASS NIPPLES



Locke#	Description
M1573	1/4" Close x 7/8" Brass Nipple
M1574	1/4" x 1 1/2" Brass Nipple
M1575	1/4" x 2" Brass Nipple
M1576	1/4" x 2 1/2" Brass Nipple
M1577	1/4" x 3" Brass Nipple
M1578	1/4" x 3 1/2" Brass Nipple
M1579	1/4" x 4" Brass Nipple
M1580	1/4" x 4 1/2" Brass Nipple
M1581	1/4" x 5" Brass Nipple
M1582	1/4" x 5 1/2" Brass Nipple
M1583	1/4" x 6" Brass Nipple
M1590	3/8" Close x 1" Brass Nipple
M1591	3/8" x 1 1/2" Brass Nipple
M1592	3/8" x 2" Brass Nipple
M1593	3/8" x 2 1/2" Brass Nipple
M1594	3/8" x 3" Brass Nipple
M1595	3/8" x 3 1/2" Brass Nipple
M1596	3/8" x 4" Brass Nipple
M1597	3/8" x 4 1/2" Brass Nipple
M1598	3/8" x 5" Brass Nipple
M1599	3/8" x 5 1/2" Brass Nipple
M1600	3/8" x 6" Brass Nipple
M0601	1/2" x Close Brass Nipple
M0602	1/2" x Shut Brass Nipple
M0603	1/2" x 2" Brass Nipple
M0604	1/2" x 2 1/2" Brass Nipple
M0605	1/2" x 3" Brass Nipple
M0606	1/2" x 3 1/2" Brass Nipple
M0607	1/2" x 4" Brass Nipple
M0609	1/2" x 5" Brass Nipple
M0610	1/2" x 5 1/2" Brass Nipple
M0611	1/2" x 6" Brass Nipple
M0613	1/2" x 12" Brass Nipple
M0615	3/4" x Close Brass Nipple
M0616	3/4" x Shut Brass Nipple
M0614	3/4" x 2" Brass Nipple
M0617	3/4" x 2 1/2" Brass Nipple
M0618	3/4" x 3" Brass Nipple
M0619	3/4" x 4" Brass Nipple
M0621	3/4" x 5" Brass Nipple
M0623	3/4" x 6" Brass Nipple
M1540	3/4" x 12" Brass Nipple
M1601	1" Close x 1 1/2" Brass Nipple
M1603	1" x 2" Brass Nipple
M1604	1" x 2 1/2" Brass Nipple
M1605	1" x 3" Brass Nipple
M1606	1" x 3 1/2" Brass Nipple
M1607	1" x 4" Brass Nipple



BRASS COUPLING

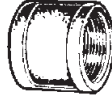

Locke#	Description
M1560	1/4" Brass Coupling
M1561	3/8" Brass Coupling
M0638	1/2" Brass Coupling
M0639	3/4" Brass Coupling
M1638	1" Brass Coupling



BRASS REDUCER



Locke#	Description
M1564	3/8" x 1/4" Brass Reducer
M1566	1/2" x 1/4" Brass Reducer
M1567	1/2" x 3/8" Brass Reducer
M0641	3/4" x 1/2" Brass Reducer
M1642	1" x 3/4" Brass Reducer
M1569	1 1/4" x 1" Brass Reducer



90° BRASS ELBOW



Locke#	Description
M1550	1/4" Brass Elbow
M1551	3/8" Brass Elbow
M0625	1/2" Brass Elbow
M0624	1/2" Brass Street Elbow
M0626	3/4" Brass Elbow
M0643	3/4" Brass Street Elbow
M1626	1" Brass Elbow
M1643	1" Brass Street Elbow



BRASS TEE



Locke#	Description
M1553	1/4" Brass Tee
M1554	3/8" Brass Tee
M0627	1/2" Brass Tee
M0628	3/4" Brass Tee
M1627	1" Brass Tee



BRASS UNIONS

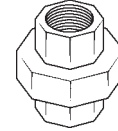

Locke#	Description
M1547	1/4" Brass Union
M1548	3/8" Brass Union
M0648	1/2" Brass Union
M0647	3/4" Brass Union
M1637	1" Brass Union



BRASS BUSHING

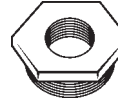

Locke#	Description
M1568	3/8" x 1/4" Brass Hex bushing
M1570	1/2" x 1/4" Brass Hex bushing
M1571	1/2" x 3/8" Brass Hex bushing
M0640	3/4" x 1/2" Brass Hex bushing
M1641	1" x 1/2" Brass Hex bushing
M1640	1" x 3/4" Brass Hex bushing
M1690	1 1/4" x 3/4" Brass Hex bushing
M1572	1 1/4" x 1" Brass Hex bushing



BRASS F.I.P. CAP

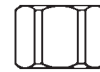

Locke#	Description
M1558	1/4" Brass FIP Cap
M1559	3/8" Brass FIP Cap
M0642	1/2" Brass FIP Cap
M1562	3/4" Brass FIP Cap

Jones Stephens Corp. BRASS PLUGS

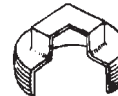

Locke#	Description
M1556	1/4" Rough Brass Plug
M1557	3/8" Rough Brass Plug
M0630	1/2" Rough Brass Plug
M0631	3/4" Rough Brass Plug
M1639	1" Rough Brass Plug
M0632	1 1/2" Rough Brass Plug
M0634	2 1/2" Rough Brass Plug
M0635	3" Rough Brass Plug
M0636	3 1/2" Rough Brass Plug
M0637	4" Rough Brass Plug

M

MISCELLANEOUS

GATE, COMPRESSIoN & BoIl eR DRAIN VAIlVeS



EVAPORATIVE COOLER VALVE



3/4" hose thread inlet & outlet. 1/8" female pipe thread side tap to A/C.

Locke#

M0485 3/4" Evaporative Cooler Valve

NIBCO[®] GATE VALVES

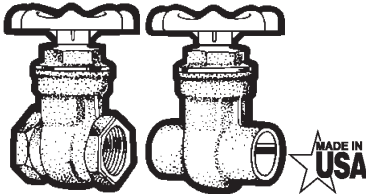

Non-rinsing stem solid wedge, wheel handle. 200 psi cold water pressure.

Locke# **THREADED ENDS**

M0581 1/2" IPS Gate Valve

M0582 3/4" IPS Gate Valve

M0583 1" IPS Gate Valve

M0584 1 1/4" IPS Gate Valve

M0585 1 1/2" IPS Gate Valve

M0586 2" IPS Gate Valve

Locke# **SOLDER ENDS**

M0587 1/2" C x C Gate Valve

M0588 3/4" C x C Gate Valve

NIBCO[®] SHUT OFF VALVES



Cast compression stops, wheel handle, IPS threaded ends.

Locke#

M0575 1/2" IPS Comp. Shut-Off Valve

M0576 3/4" IPS Comp. Shut-Off Valve



COMPRESSION VALVES

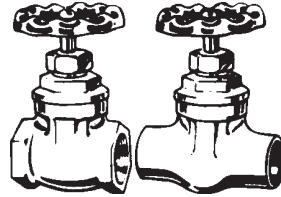

For use with water, oil or air. Brass body.

Locke#

M0495 1/2" Comp. Stop CxC, 125#

M0496 3/4" Comp. Stop CxC, 125#

NIBCO[®] MIP BOILER DRAINS

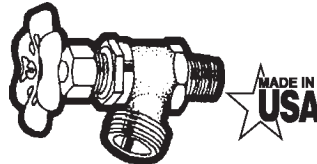

1/2" IP female or 1/2" nominal copper, rough brass.

Locke#

M0577 1/2" MIP Boiler Drains

M0578 3/4" MIP Boiler Drains

NIBCO[®] FIP BOILER DRAINS

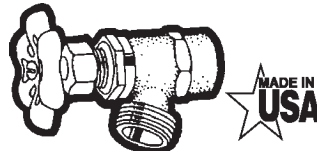

Cast compression stops, threaded ends.

Locke#

M0573 1/2" FIP Boiler Drains

M0574 3/4" FIP Boiler Drains

TBP FEMALE THREAD BOILER DRAIN

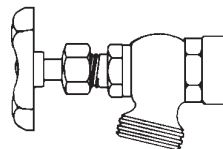

Stuffing box, hose thread. Brass.

Locke#

M0489 1/2" Brass Female Boiler Drain

M0490 3/4" Brass Female Boiler Drain



MALE THREAD BOILER DRAINS

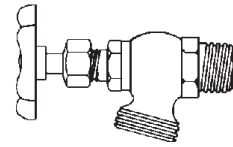

Stuffing box, male hose thread. Brass.

Locke#

M0487 1/2" Brass Male Boiler Drains

M0488 3/4" Brass Male Boiler Drains

TBP BOILER DRAIN

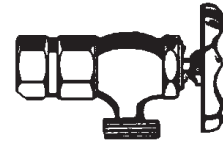

For copper. Pipe 5/8" OD with stuffing box. Brass, with compression ring. Fits 1/2" ID or 3/8" OD copper pipe.

Locke#

M0486 5/8" OD Boiler Drain for copper

NIBCO[®] LAWN FAUCETS SILLCOCK

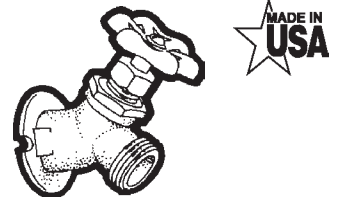

Female IP, regular pattern.

Locke#

M0579 1/2" Female IP, Lawn Faucets

M0580 3/4" Female IP, Lawn Faucets

TBP ANGLE SILLCOCK

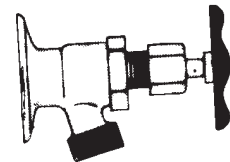

Pipe threads. Brass construction with flange.

Locke#

M0559 1/2" FIP Brass Angle Sillcock

M | MISCELLANEOUS

TBP

HOSE BIBBS

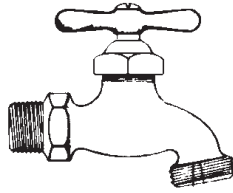

Rough brass with "T" handle.

Locke#

- M0491** 1/2" Brass Hose Bibb
- M0492** 3/4" Brass Hose Bibb

WOODFORD® MODEL 24 HOSE BIBBS

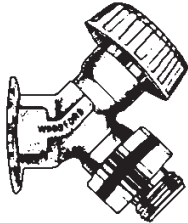

Locke#

- M0938** 1/2" Rough Brass Hose Bibb
- M0939** 1/2" Rough Chrome Hose Bibb
- M0940** Tan wheel handle for **M0938-M0939**
- M0669** Tee Key Handle for **M0938-M0939**
- M0937** 34HF Brass Vacuum Breaker for **M0938-M0939**
- M0983** 3/4" R chrome Plated Hose Bib
- M0984** 3/4" Polished Chrome Hose Bib

We Do More Than Just Meet our Competition, We Beat Them. Compare our prices and save!!



1/4 TURN HYDRANTS



Quarter Turn easy open design with soft grip handle. Features traditional rising stem design for simple maintenance and years of life.

D Style: 1/2" MPT & 1/2" Female Sweat

Locke#

- M4170** P-164D04 4" 1/4 Turn Hydrant
- M4171** P-164D06 6" 1/4 Turn Hydrant
- M4172** P-164D08 8" 1/4 Turn Hydrant
- M4173** P-164D10 10" 1/4 Turn Hydrant
- M4174** P-164D12 12" 1/4 Turn Hydrant
- M4175** P-164D14 14" 1/4 Turn Hydrant

T Style: IPS Combo, 3/4" MPT & 1/2" FPT

Locke#

- M4180** P-164T04 4" 1/4 Turn Hydrant
- M4181** P-164T06 6" 1/4 Turn Hydrant
- M4182** P-164T08 8" 1/4 Turn Hydrant
- M4183** P-164T10 10" 1/4 Turn Hydrant
- M4184** P-164T12 12" 1/4 Turn Hydrant
- M4185** P-164T14 14" 1/4 Turn Hydrant

Locke#

Parts

- M4168** P-164KT-805 Soft grip handle and screw kit
- M4169** 336-0002 Backflow check valve for P-164 Hydrants
- M4187** C-108KT-808 Loose key only for **M4188**
- M4188** C-134KT-804 Handle to loose key conversion kit
- M4189** C-134KT-802 Seat washer kit
- M4193** C-134KT-803 Packing kit
- M4194** C-144KT-806 Vac breaker kit



COMMERCIAL HYDRANT



This valve installs through a single 1-3/8" hole.

Locke#

- M1974** C-634N10 10" Heavy Commercial Wall Hydrant
- M1975** C-634N12 12" Heavy Commercial Wall Hydrant
- M1976** C-634N14 14" Heavy Commercial Wall Hydrant
- M1980** C-634BX1 Satin Hydrant Box For C634 Faucets
- M1981** C-634BX2 Brass Hydrant Box For C634 Faucets



ARROW-BREAKER ANTI-SIPHON FROST FREE HYDRANT

With Built-In Vacuum Breakers



Locke#

- M4222** 465-8" 1/2" FIP or 3/4" MIP
- M4223** 465-10" 1/2" FIP or 3/4" MIP
- M4224** 465-12" 1/2" FIP or 3/4" MIP
- M4225** 465-14" 1/2" FIP or 3/4" MIP
- M4232** 466-2" 1/2" Sweat or 1/2" MIP
- M4226** 466-4" 1/2" Sweat or 1/2" MIP
- M4227** 466-6" 1/2" Sweat or 1/2" MIP
- M4228** 466-8" 1/2" Sweat or 1/2" MIP
- M4229** 466-10" 1/2" Sweat or 1/2" MIP
- M4230** 466-12" 1/2" Sweat or 1/2" MIP
- M4231** 466-14" 1/2" Sweat or 1/2" MIP
- M4260** 464-4" 1/2" Shark Bite
- M4261** 464-6" 1/2" Shark Bite
- M4262** 464-8" 1/2" Shark Bite
- M4263** 464-10" 1/2" Shark Bite
- M4264** 464-12" 1/2" Shark Bite
- M4265** 464-14" 1/2" Shark Bite



INTERNAL VACUUM BREAKER FREEZELESS WALL HYDRANT



- Approved to ASSE 1019-A and UPC
- Smartturn 180 Half-Turn Operation
- Satin Nickel Plated Cast Brass Body
- High Impact Operating Handle
- Uses Standard parts from Prier
- Manufactured by Prier in Kansas City, MO
- Includes Siding Wedge for installation
- Spout Alignment mark on Seat
- Each valve factory tested to hold 80psi
- Removable Inspection Collar

Locke#

- M4234** 408-8" Hydrant 1/2" MIP x 1/2" SWT
- M4235** 408-10" Hydrant 1/2" MIP x 1/2" SWT
- M4236** 408-12" Hydrant 1/2" MIP x 1/2" SWT
- M4240** 409-8" Hydrant 3/4" MIP x 1/2" FIP
- M4241** 409-10" Hydrant 3/4" MIP x 1/2" FIP
- M4242** 409-12" Hydrant 3/4" MIP x 1/2" FIP
- M4246** 420-8" Hydrant 1/2" PEX
- M4247** 420-10" Hydrant 1/2" PEX
- M4248** 420-12" Hydrant 1/2" PEX

M

MISCELLANEOUS



FROST PROOF LAWN FAUCETS

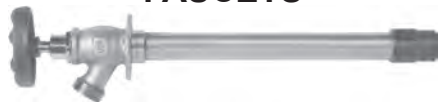

1/2" FIP / 3/4" MIP frost proof lawn faucet.

Locke#	455 SERIES
M4152	1/2" FIP or 3/4" MIP x 8" F.P.
M4153	1/2" FIP or 3/4" MIP x 10" F.P.
M4154	1/2" FIP or 3/4" MIP x 12" F.P.
M4155	1/2" FIP or 3/4" MIP x 14" F.P.
M4162	8" Stem for M4152
M4163	10" Stem for M4153
M4164	12" Stem for M4154
M4165	14" Stem for M4155
M4151	#3 Handle Packing
M4166	Backflow assembly for 455BFP
M4167	Drain assembly for 455BFP



ANTI-SIPHON FROST PROOF LAWN FAUCET



Integral vacuum breaker & self draining features.

Locke#	480 SERIES
M4138	1/2" SWT or 1/2" M.I.P. x 2"
M4139	1/2" SWT or 1/2" M.I.P. x 4"
M4140	1/2" SWT or 1/2" M.I.P. x 6"
M4141	1/2" SWT or 1/2" M.I.P. x 8"
M4142	1/2" SWT or 1/2" M.I.P. x 10"
M4143	1/2" SWT or 1/2" M.I.P. x 12"
M4144	1/2" SWT or 1/2" M.I.P. x 14"
M0590	1/2" F.I.P or 3/4" M.I.P. x 8"
M0591	1/2" F.I.P or 3/4" M.I.P. x 10"
M0592	1/2" F.I.P or 3/4" M.I.P. x 12"
M0593	1/2" F.I.P or 3/4" M.I.P. x 14"
M0589	59BFPC Vac Breaker
M0594	#11 Replacement Oval Handle



HOSE BIBB LOCK



- Protects against tampering and theft
- It will work on a hose bib or a sill cock
- Stops wasteful leaks
- Foolproof, two-piece design

Locke#	
M4216	Hose Bibb Lock



ANTI-SIPHON FROST PROOF LAWN FAUCETS



With integral vacuum breaker and vandal-resistant vented cap.

Locke#	420 SERIES
M4129	1/2" Sweat or 1/2" MIP x 4" F.P.
M4130	1/2" Sweat or 1/2" MIP x 6" F.P.
M4131	1/2" Sweat or 1/2" MIP x 8" F.P.
M4132	1/2" Sweat or 1/2" MIP x 10" F.P.
M4133	1/2" Sweat or 1/2" MIP x 12" F.P.
M4134	1/2" Sweat or 1/2" MIP x 14" F.P.
M4120	1/2" FIP or 3/4" MIP x 10" F.P.
M4121	1/2" FIP or 3/4" MIP x 12" F.P.
M4115	Vacuum Breaker Repair Kit

TBP FROSTPROOF SILLCOCK



Bronze and copper. Satin nickel exterior with chrome barrel. Lock shield cap. Brass operating rod. Cast bronze raised seat.

Locke#		
M0525	4"	1/2" MIP x 1/2" C
M0526	6"	1/2" MIP x 1/2" C
M0527	8"	1/2" MIP x 1/2" C
M0528	10"	1/2" MIP x 1/2" C
M0529	12"	1/2" MIP x 1/2" C
M0530	14"	1/2" MIP x 1/2" C
M0535	8"	3/4" MIP x 1/2" FIP
M0536	10"	3/4" MIP x 1/2" FIP
M0537	12"	3/4" MIP x 1/2" FIP



VERTICAL/HORIZONTAL HOT & COLD WALL HYDRANT



Due to its patented design, the same product is available as horizontal or vertical. Self-draining Anti-Siphon Vacuum Breaker and Backflow Check Valve

Locke#		
M1428	C108-10	10" Hydrant
M1429	C108-12	12" Hydrant



FREEZELESS ANTI-SIPHON HYDRANT



Residential, freezeless hydrant with anti-siphon vacuum breaker, solid brass body, seat and stem ends.

D Style: 1/2" MPT & 1/2" Female Sweat

Locke#		
M4198	C-144D04	4" F.P. Hydrant
M4199	C-144D06	6" F.P. Hydrant
M4200	C-144D08	8" F.P. Hydrant
M4201	C-144D10	10" F.P. Hydrant
M4202	C-144D12	12" F.P. Hydrant
M4203	C-144D14	14" F.P. Hydrant

T Style: IPS Combo, 3/4" MPT & 1/2" FPT

Locke#		
M4204	C-144T04	4" F.P. Hydrant
M4206	C-144T06	6" F.P. Hydrant
M4208	C-144T08	8" F.P. Hydrant
M4210	C-144T10	10" F.P. Hydrant
M4211	C-144X10	10" Length 1/2" Crimp Pex Hydrant
M4212	C-144T12	12" F.P. Hydrant
M4214	C-144T14	14" F.P. Hydrant
M4189	C-134KT-802	Seat Washer Kit
M4190	231-01US	Universal stem f/E
M4193	C-134KT-803	Stem packing kit
M4194	C-144KT-806	Vacuum Breaker Assembly Kit
M4196	C-144KT-807	Repair Kit, no stem
M4197	C-134KT-805	All Style Handle Kit
M4188	C-134KT-804	Loose Key Conversion Kit
M4187		Loose Key Only

OLD STYLE PRIER FAUCET REPAIR PARTS

Locke#		
M4191	C-134KT-807	Repair Kit for both new and old style C-134 Prier hydrants, without breaker
M4195	C-134US	Old style universal stem

TBP

ANTISIPHON FROST PROOF VALVE



Provides the same non-freezing quality of our standard model, while assuring protection against back siphoning.

Locke#

- M0790** 1/2" x 10" F.P. Sillcock
- M0791** 1/2" x 12" F.P. Sillcock
- M0792** 1/2" x 14" F.P. Sillcock



FROSTPROOF SILLCOCK #378

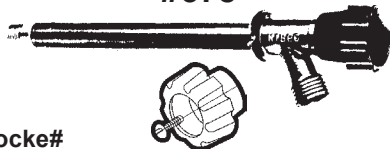

Locke#

- M0779** 1/2" x 8" F.P. Sillcock #378
- M0780** 1/2" x 10" F.P. Sillcock #378
- M0781** 1/2" x 12" F.P. Sillcock #378
- M0644** Handle for Mansfield sillcock

WOODFORD® 65 SERIES WALL HYDRANT



Locke#

- M0677** 4" Comm. Hydrant, key T44
- M0678** 6" Comm. Hydrant, key T44
- M0679** 8" Comm. Hydrant, key T44
- M0680** 10" Comm. Hydrant, key T44
- M0681** 12" Comm. Hydrant, key T44
- M0682** 14" Comm. Hydrant, key T44
- M0669** Tee Key Handle for M0677-M0682

WOODFORD® WALL HYDRANT BOX



Chrome finish recessed box.

Locke#

- M0683** 65BX Wall Hydrant Box for model 65 Hydrant

WOODFORD® FREEZE-PROOF WALL FAUCET



Combination 1/2" Male Pipe Thread & 1/2" Female Copper Water Tube Inlet. Metal Handle.
1/2" MIP x 1/2" FIP.

Locke#

- M0538** 17CP-8 8" Wall Hydrant
- M0646** 17C-10 10" copper wall hydrant
- M0540** 17CP-10 10" Wall Hydrant
- M0545** 17CP-12 12" Wall Hydrant
- M0550** 17CP-3 3/4"x14" Wall Hydrant
- M0313** 30099 #14, #17 Handle
- M4215** 17W-10 10" Wall Hydrant with Wirsbo male insert connection
- M4213** 17-PX 10" Wall Hydrant 1/2" Pex Tube insert

WOODFORD® HOT & COLD WALL HYDRANTS



Push & Turn hot water handle for safety. Faucet drains automatically when hose is removed.

Locke#

- M0941** 22CP 12" horizontal hydrant. CP Inlet, 1/2" MIP, 1/2" female copper
- M0942** V22CP 12" vertical hydrant. ASSE 1019 Type A approved, CSA certified, UPC/IAPMO Listed

WOODFORD® FREEZELESS WALL FAUCET MODEL 25CP.

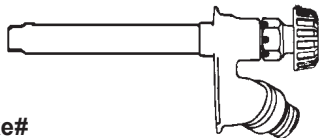

Locke#

- M0541** 10" Freezeless Wall Faucet
- M0542** 12" Freezeless Wall Faucet
- M0543** 12" Freezeless Wall Faucet loose key; use M669 Tee key handle
- M0314** Metal Handle, Model 25
- M0317** 34HA Brass Vacuum Breaker for #25 Wall Hydrant

WOODFORD® METAL HANDLE

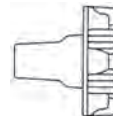

For model #14, #17, and #22 Wall Hydrant

Locke#

- M0551** Metal Handle

WOODFORD® MODEL 17 REPAIR KIT

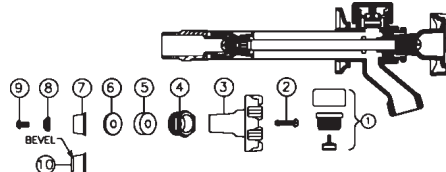

Includes (1-10): VB float kit, handle & screw, packing, packing nut & washer, 2 check valves, & a retainer screw.

Locke#

- M0310** RK-17 Model 17 Repair Kit

WOODFORD® MODEL 25/26/27 REPAIR KIT

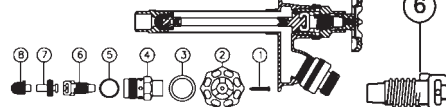

Includes (1-8): handle screw, wheel handle, drain guard, head nut, head nut gasket, stem screw, drain valve assembly, & plunger assembly.

Locke#

- M0311** RK-25 Model 25/26/27 Kit

WOODFORD® MODEL 60/65/67 REPAIR KIT

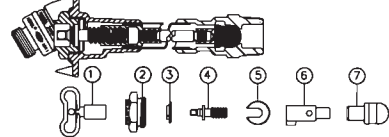

Includes (1-7): tee key, head nut, stem washer and screw, "C" washer, yoke nut and plunger. Chrome Repair Kit.

Locke#

- M0312** RK-65 Model 60/65/67 Kit

SEE TOOLS FOR 4 WAY HYDRANT KEY - T0044.

M MISCELLANEOUS

WOODFORD® FREEZELESS YARD HYDRANT

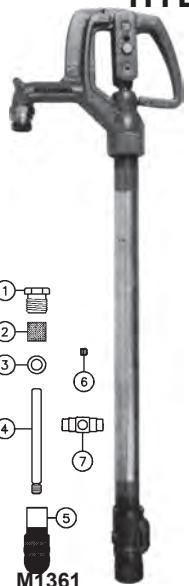

W34 hydrants are used for filling field spray equipment, cleaning tools & equipment, lawn & garden care, watering livestock, fire protection - immediate water flow even in sub-zero temperatures.

Features:

- 1 Pc Variable Flow Plunger
- Maintenance & Repair - can be done from top of unit w/o excavating.
- Tamperproof Lock
- Rod Guide-eliminates side pull
- Long Life Teflon Packing
- Long Life Valve Seat



M1362

Specifications:

Max. Pressure - 125 psi
Max. Temperature - 120° F
Female Inlet - ¾" N.P.T.
Casing - 1" Galvanized steel pipe
Operating Rod - 3/8" Galvanized steel pipe
Drain Hole - Tapped - 1/8" N.P.T.

Locke#

M1354	W34	¾" x 1' Yard Hydrant
M1355	W34	¾" x 2' Yard Hydrant
M1356	W34	¾" x 3' Yard Hydrant
M1357	W34	¾" x 4' Yard Hydrant
M1361	RK-W34	Hydrant Repair Kit (Includes #1-7)
M1362	10105	Plunger for Y34 & W34 (#18)

WOODFORD® FREEZELESS SANITARY YARD HYDRANT



Backflow Protected Automatic Draining

The Model S3 hydrant is designed for use anywhere potable water is required. It is equipped with a diverter spout which allows the hydrant to be operated from the backflow preventer. The diverter also allows air to enter the system when hydrant is shut off, allowing backflow preventer and head assembly to drain into reservoir avoiding freezing of hydrant even with hose attached. No water is introduced into the subsoil under normal use. An important feature of the S3 is easy maintenance. The entire working portion of the hydrant can be removed from the reservoir without any excavation. **NOTICE: For Winter Use:** The hydrant must be operated at full

flow, through the diverter, for a min. of 30 seconds before & after each use to drain the hydrant & prevents freezing.

Specifications: HOSE CONNECTION BACKFLOW PREVENTER

- Nidel Model 37HF
- Field Testable
- ASSE 1052 Approved
- 2 Check Valves
- Female Inlet** - 1" N.P.T.;
- Max. Temperature** - 120° F
- Min. Pressure** - 20 psi;
- Max. Pressure** - 100 psi



M1363

Locke#

M1340	S3-2	1"x2' Sanitary Hydrant
M1341	S3-3	1"x3' Sanitary Hydrant
M1363	10106	1" Plunger for S3

MERRILL® FROST PROOF YARD HYDRANT



M0553

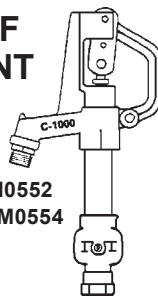

**M0552
& M0554**

Locke#

M0552	¾" x 2' Bury Yard Hydrant
M0554	¾" x 3' Bury Yard Hydrant
M1666	¾" x 6' Bury Yard Hydrant
M0553	Plunger for M0552 & M0554
M1552	1" x 2' Bury Yard Hydrant HI-CAPACITY

WOODFORD® IOWA® FREEZELESS YARD HYDRANT

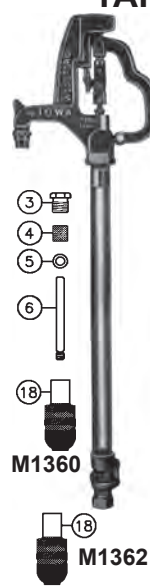

Iowa hydrants are used for filling field spray equipment, cleaning tools & equipment, lawn & garden care, watering livestock - immediate water flow even in sub-zero temperatures.

Features:

- Adjustable Link
- Rod Guide-eliminates side pull
- Flow-Finder & Lock
- Long Life Teflon Packing
- 1 Pc Variable Flow Plunger
- Maintenance & Repair - interchangeable parts on Iowa

Max. Temperature: 120°F
Max. Pressure: 125 psi

Locke#

M1349	Y34	¾" x 1' Yard Hydrant
M1350	Y34	¾" x 2' Yard Hydrant
M1351	Y34	¾" x 3' Yard Hydrant
M1352	Y34	¾" x 4' Yard Hydrant
M1360	RK-Y34	Repair Kit (Includes items 3-6 & 18)
M1362	10105	Plunger for Y34 & W34 (#18)



1" SPILL RESISTANT PRESSURE VACUUM BREAKER ASSEMBLY



Maximum working water pressure 150 PSI
 Maximum working water temperature 180°F
 Hydrostatic test pressure 300 PSI
 Threaded connections ANSI B1.20.1
 Replaceable thermoplastic modular cartridge.
 Spill resistant feature for indoor use.

Locke#

M1700	460	1" Spill Resistant Pressure Vacuum Breaker Assembly
--------------	-----	---

**We appreciate
Your
Business!**

Honeywell THERMOSTATIC MIXING VALVE



- Dual purpose mixing or diverting valves
- Constant water temperature under changing operating conditions
- Reliable at minimum flow of 0.5 gpm
- Nickel-plated brass construction, EPDM O-rings
- Straight through design (hot and cold at the same level)
- Max pressure 150 psi (1034 kPa)
- Max temperature 212 F (100 C)
- Tamper resistant design
- Valve trapping not required
- ASSE, CSA and IAPMO listed

E0260 AM100C-UT-1 1/2" NPT Union Thermostatic Mixing Valve

E0261 AM101-UT-1 3/4" NPT Union Thermostatic Mixing Valve

E0262 AM101C1070-UPEX-1 3/4" PEX Union Thermostatic Mixing Valve

E0263 AM101C1070-US-1 3/4" Sweat Union Thermostatic Mixing Valve

Honeywell AMX SERIES THERMO- STATIC MIXING VALVES *Direct-Connect Model*



The AMX mixing valve cuts installation time and number of parts in half.

- Adjustable Temperature 90° to 130°.
- Teflon® Coating increases life
- Direct Connection To Water Heater (NPT bottom connection attaches easily.)
- Solid Brass Design for durability.
- Built-In Check Valve prevents reverse flow of hot water through the cold port.
- ASSE 1017 point-of-source Approved
- Maximum temperature 200° F
- Maximum working pressure 150 psi.
- Reliable at minimum flow of 0.5 gpm

E0264 AMX101-UT-1 3/4" NPT Union Thermostatic Mixing Valve

Honeywell UNDERSINK UNIVERSAL THERMOSTATIC MIXING VALVES

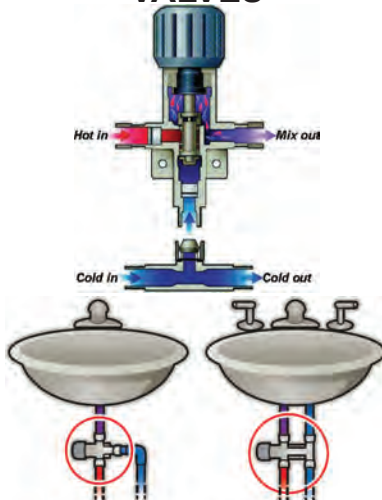

Universal 3 or 4 Port connection for 3/8" compression undersink applications. Includes internal check valves in hot and cold ports to prevent cross flow. Easy installation kit includes 3/8 compression nuts, ferrules and stand-offs for secure mounting. Forged brass body construction. Tamper resistant temperature control hand wheel locks into desired temperature position.

- Includes internal check valves in hot and cold ports to prevent cross flow.
- Tamper resistant hand wheel locks into desired temperature position
- Temperature adjustment range 80-120F
- Controls temperature with flow as low as 0.5 gpm
- Forged brass body with pilot holes for secure mounting
- ASSE 1016 and ASSE 1070 listed

Locke#

E0265 UMV-304U 3/8" Compression Thermostatic Mixing Valve

*We appreciate
Your
Business!*

Honeywell DIALSET PRESSURE REDUCING VALVE



- Dial is calibrated in 10 psi increments to allow quick and accurate adjustment of outlet pressure.
- Flow capacity and accuracy make the DS05 suitable for potable water service and most irrigation applications.
- High pressure (400 psi) inlet rating.
- Non-corroding unitized cartridge contains all working parts and is easily replaceable.
- Bronze body with stainless steel and engineered thermoplastic internal parts.
- Balanced single seat for accurate pressure output under varying inlet pressures.
- Inlet and outlet are internally threaded female NPT, and externally threaded for use with union assemblies.
- Built-in strainer and thermal bypass.
- One model can be used in low, standard or high pressure applications.

Locke#

E0267 DS05C1055 Dialset Pressure Reducing Valve 3/4" UNSWT

Honeywell COMPACT 3/4" PRESSURE REDUCING VALVE



- Bronze body construction with stainless steel and engineered thermoplastic internal parts
- One piece non-corroding cartridge
- Fully balanced regulator mechanism with fabric reinforced diaphragm
- Includes balanced seat for accurate pressure output under varying inlet pressures up to 400psi
- Inlet and outlet internally and externally threaded (NPT)
- Built-in strainer and thermal by-pass
- ASSE 1003 and IAPMO listed

Locke#

E0266 D05T1029 Compact 3/4 in. Pressure Reducing Valve

M
MISCELLANEOUS

WILKINS

a ZURN company

PRESSURE VACUUM BREAKER ASSEMBLY



Designed for installation on potable water lines to protect against backsiphonage of contaminated water into the potable water supply. Assembly shall provide protection where a potential health hazard exists.

Locke#

M1708	720A	1/2" Pressure Vacuum Breaker Assembly
M1709	720A	3/4" Pressure Vacuum Breaker Assembly
M1710	720A	1" Pressure Vacuum Breaker Assembly
M1711	720A	1 1/4" Pressure Vacuum Breaker Assembly
M1712	720A	1 1/2" Pressure Vacuum Breaker Assembly
M1713	720A	2" Pressure Vacuum Breaker Assembly

WILKINS

a ZURN company

SPILL RESISTANT PRESSURE VACUUM BREAKER ASSEMBLY



Designed for installation on indoor and outdoor point of use applications to protect against backsiphonage of contaminated water into the water supply.

During start-up and operation a separate diaphragm seals the air inlet from the water supply preventing spillage. The assembly is designed for use under constant pressure and provides protection where a potential health hazard exists.

Locke#

M1700	460	1" Spill Proof Backflow Preventer
--------------	-----	-----------------------------------

WILKINS

a ZURN company

WATER PRESSURE REDUCING VALVE



Designed for installation on potable water lines to reduce high inlet pressure to a lower outlet pressure. The unitized replaceable cartridge reduces time involved with cleaning and maintenance. The direct acting integral bypass design prevents buildup of excessive system

pressure caused by thermal expansion. The balanced piston design enables the regulator to react in a smooth and responsive manner to changes in system flow demand, while at the same time, providing protection from inlet pressure changes

Locke#

M1692	70	1/2" Water Pressure Reducing Valve
M1693	70	3/4" Water Pressure Reducing Valve
M1694	70	1" Water Pressure Reducing Valve

WATTS®

2" DOUBLE CHECK VALVE ASSEMBLY



Series 007 Double Check Valve Assemblies prevent the backflow of contaminated water into the potable water supply. It consists of a bronze 2 in body construction that is easy to maintain and service. Series 007 is ideal at referenced cross-connections identified as non-health hazard applications. Check with local inspection authorities for installation requirements. Maximum Working Pressure: 175psi

Locke#

M1276	0062427	2" Double Check Valve Assembly
--------------	---------	--------------------------------

WATTS®

AIR GAPS



Locke#

M1277	0881576	3/4"-1" Air Gap
M1278	0881577	1 1/4"-2" Air Gap



M | MISCELLANEOUS



WATER PRESSURE REDUCING VALVE

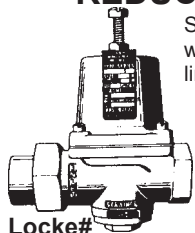

Set at 45 lb. Reduces water pressure in service lines.

Locke#

M0546 3/4" Water Press. Reduc. Valve

M0548 1" Water Press. Reduc. Valve



WATER PRESSURE REDUCING VALVE



Set at 50 psi. Initial pressure up to 300 psi. NPT thread female union in x NPT fem. out.

Locke#

M1025 1 1/4" Water Press. Reduc. Valve

M1026 1 1/2" Water Press. Reduc. Valve

M1027 2" Water Pressure Reduc. Valve



009QT REDUCED PRESSURE ZONE ASSEMBLY



Locke#

M0999 0062094 1/2" Reduced Pressure Backflow Preventer

M1000 0063030 3/4" Reduced Pressure Backflow Preventer

M1132 0887787 3/4" Total rubber parts kit for **M1000**

M1001 0063020 1" Reduced Pressure Backflow Preventer

M1002 0062920 1 1/4" Reduced pressure backflow preventer

M1003 0062921 1 1/2" Reduced pressure backflow preventer

M1004 0063010 2" reduced pressure backflow preventer



ANTI-SIPHON, SPILL-RESISTANT VACUUM BREAKER



Approvals



Locke#

M1120 008PCQT 1/2" Vacuum Breaker



REDUCED PRESSURE ASSEMBLY



Locke#

M1015 800M4QT 3/4" Press. Breaker

M1016 800M4QT 1" Press. Breaker

M1024 800M4QT 1 1/4" Press Breaker

M1028 800M4QT 1 1/2" Press Breaker

M1029 800M4QT 2" Press. Breaker

M1139 0887701 Repair Kit for 800M4QT (Hood & Screw Assembly)

FLOAT VENT KIT FOR 800M4QT BACKFLOW PREVENTORS

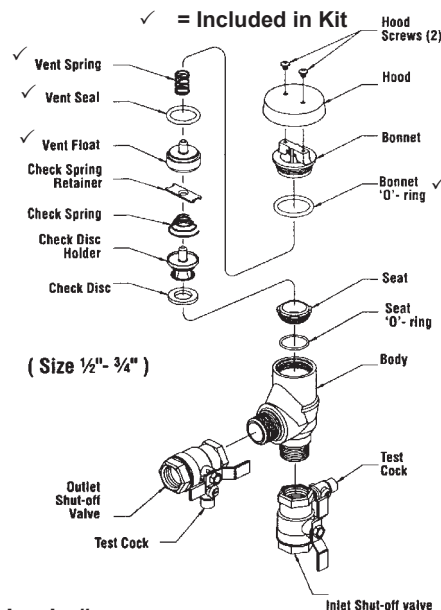

Locke#

M1017 RK800M4V Float Vent Kit for 800M4 QT 1/2 & 3/4" Valve

M1018 RK800M4V Float Vent Kit for 800M4 QT 1" Valve



STAINLESS STEEL REDUCED PRESSURE ASSEMBLY



Locke#

M1009 SS009-M3-QT 1/2" Stainless Steel Reduced pressure backflow preventer



MXF CHECK VALVE



For Submersible Pumps.

Locke#

S0075 1" MIP x 1" FIP Check Valve

S0074 1" FIP x 1 1/4" MIP Check Valve



FXF CHECK VALVE



Locke#

M1517 3/4" FIP x 3/4" FIP Check Valve

M1518 1" FIP x 1" FIP Check Valve

M1519 1 1/4" FIP x 1 1/4" FIP Check Valve



SWING CHECK VALVE



200 lb. pressure for water, oil or air. Cast Brass. Main use is to prevent backflow of fluids. CxC

Locke#

M1514 1/2" Swing Check Valve CxC

M1515 3/4" Swing Check Valve CxC

M | MISCELLANEOUS

TBP SWING CHECK VALVE

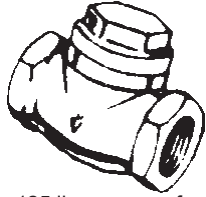

Pipe thread - 125 lb. pressure for water, oil or air, up to 210 F. Brass main use is to prevent backflow of fluids.

Locke#

M0514 1/2" Swing Check Valve IPS

M0515 3/4" Swing Check Valve IPS

M0516 1" Swing Check Valve IPS

M0517 1 1/4" Swing Check Valve IPS

M0518 1 1/2" Swing Check Valve IPS

M0519 2" Swing Check Valve IPS

WATTS® BACKFLOW PREVENTER FOR VENDING MACHINE WATER LINES & CARBONATED BEVERAGE (REQUIRED BY CODE)



No. 9D is for protection against backflow of carbon dioxide gas & carbonated water into the water supply system to vending machines thus eliminating the hazardous reaction of carbon dioxide with copper tubing.

Locke#

M1019 9D 1/2" FIP Backflow Preventer with Intermediate Atmosphere Vent- Max. Pressure 175 PSI

M1012 SD2-MF 3/8" Faucet Vented Dual check backflow preventer; Meets ASSE Std. 1032 & Std. 1022, NSF-18

M1013 SD3-MF 3/8" Faucet Vented Dual check backflow preventer with strainer; Meets ASSE Std. 1022, NSF-18

WATTS® RESIDENTIAL DUAL CHECK VALVE BACKFLOW PREVENTERS

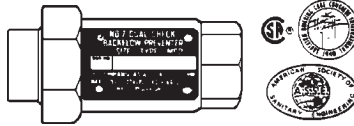

Provides backflow protection by containment at the water meter. The Dual Check is a versatile backflow preventer. It operates efficiently in the horizontal or vertical position & under intermittent or continuous pressure. Tested & certified to meet or exceed the 1988 revision of ANSI/ASSE St. 1024. CSA certified to Std. No. B64.6.

Locke#

M1022 #7 - 3/4" Dual Check Backflow Preventer

M1023 #7 - 1" Dual Check Backflow Preventer

WATTS® DOUBLE CHECK ASSEMBLY



Locke#

M1010 007QT 3/4" Double Check

M1011 007QT 1" Double Check

WATTS® STRAINER KITS FRO BACKFLOW PREVENTERS



Protects backflow preventers from foreign debris. Includes wye strainer & nipple.

Locke#

M1030 1/2" Wye Strainer Kit with Nipple

M1031 3/4" Wye Strainer Kit with Nipple

M1032 1" Wye Strainer Kit with Nipple

M1033 1 1/4" Wye Strainer Kit with Nipple

M1034 1 1/2" Wye Strainer Kit with Nipple

M1035 2" Wye Strainer Kit with Nipple



BACKFLOW PREVENTER

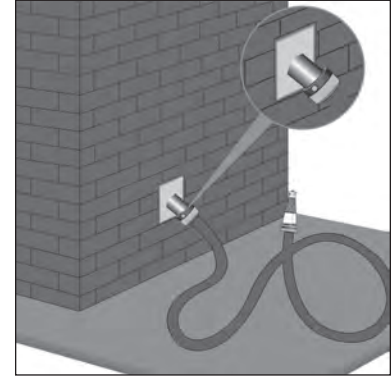

Self-draining hose connection vacuum breakers. Prevents dangerous back siphoning; automatically self-drains when all attachments are removed completely from the valve's outlet. Protects the valve and faucet from freezing and rupturing in cold weather. Constructed with brass body and adapter. Buna O-ring and seat disc, steel set screw, stainless steel springs and the highest quality molded parts.

Locke#

M0599 3/4" Hose Backflow Preventor

TBP HOSE FAUCET BACKFLOW PREVENTER VACUUM BREAKER

Mounts on outside water hydrant like this.

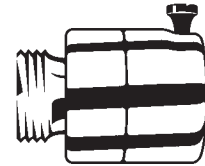

Required on all new FHA houses. Vacuum breaker prevents backflow of water into water system. When using liquid sprays for your lawn garden hose attachments, if a faucet in the house is turned on, the vacuum breaker prevents the liquid spray solution from backing into the house water system.

Locke#

M0558 3/4" Hose Faucet Back-flow preventer vacuum breaker

M MISCELLANEOUS

BAI I VALVES

WATTS® BRONZE BALL VALVES



- 2-Piece ball valves.
- Complies with MSS-SP-110
- 1/4" - 3" have reinforced TFE Seats
- For residential, commercial & industrial applications.
- Suitable for a full range of liquids & gases.
- Sizes 1/4" - 2" are pressure rated at 150 PSI WSP, 600 PSI WOG (non-shock).

B-6000 NPT FEMALE CONNECTIONS

Locke#

M1100	1/4" FIP Ball Valve, full port
M1101	3/8" FIP Ball Valve, full port
M1102	1/2" FIP Ball Valve, full port
M1103	3/4" FIP Ball Valve, full port
M1104	1" FIP Ball Valve, full port
M1105	1-1/4" FIP Ball Valve, conv.
M1106	1-1/2" FIP Ball Valve, conv.
M1107	2" FIP Ball Valve, conv. port
M1109	3" FIP Ball Valve, conv. port

WATTS® BRONZE BALL VALVES



- 2-Piece Ball valves.
- Reinforced PTFE seats
- Blowout Proof Stem
- Electroless nickel plated brass ball
- Complies with MSS-SP-110
- Adjustable stem packing gland
- Sizes 1/4" - 2" are pressure rated at 600 psi WOG (non-shock), 150 psi WSP

B-6001 CONVENTIONAL PORT

Locke#

M1122	1/2" CXC Ball Valve
M1123	3/4" CXC Ball Valve
M1124	1" CXC Ball Valve
M1125	1 1/4" CXC Ball Valve
M1126	1 1/2" CXC Ball Valve
M1127	2" CXC Ball Valve

WATTS® SERIES B-6080/B6081 VALVES



Bronze, full port valves. For Residential, Commercial and Industrial applications.

- Suitable for temperatures from 0° - 350° F at 50 psi.
- Complies with MSS-SP-110.
- Model B-6080, sizes: 1/2"-2" are NPT female connections.
- Model B-6081, sizes: 1/2" - 2" are solder connections.
- Pressure rated at 400 psi WOG (non-shock) & 125 psi saturated steam.
- PTFE seats and seals.

B-6081 CXC VALVES - 1/2" - 2" * SOLDER ENDS, FULL PORT

Locke#

M1141	3/4" CXC Full Port Ball Valve
M1142	1" CXC Full Port Ball Valve
M1143	1 1/4" CXC Full Port Ball Valve
M1144	1 1/2" CXC Full Port Ball Valve
M1145	2" CXC Full Port Ball Valve*

*= Not Available In Larger Sizes At This Time

MATCO-NORCA™ BRASS BALL VALVES FULL PORT



Locke#

M0925	1/2" IPS Brass Ball Valve
M0926	3/4" IPS Brass Ball Valve
M0927	1" IPS Brass Ball Valve
M0928	1 1/4" IPS Brass Ball Valve
M0929	1 1/2" IPS Brass Ball Valve
M0930	2" IPS Brass Ball Valve



M0931	1/2" C x C Brass Ball Valve
M0932	3/4" C x C Brass Ball Valve
M0933	1" C x C Brass Ball Valve
M0934	1 1/4" C x C Brass Ball Valve
M0935	1 1/2" C x C Brass Ball Valve
M0936	2" C x C Brass Ball Valve

BOSTON METAL PRODUCTS, LTD FULL PORTBALL VALVES



600WOG/150WSP rated. Forged brass valve with female NPT connections. Valve conforms to WW-V-35, type II, Style 2

Locke#

M1160	USA0259101	1/4" FIP
M1161	USA0389101	3/8" FIP
M1162	USA0509101	1/2" FIP
M1163	USA0759101	3/4" FIP
M1164	USA1009101	1" FIP
M1165	USA1259101	1 1/4" FIP
M1166	USA1509101	1 1/2" FIP
M1167	USA2009101	2" FIP

BOSTON METAL PRODUCTS, LTD FULL PORT BALL VALVES



600WOG/150WSP rated. Forged brass valve with solder joint end connections. Valve conforms to WW-V-35, type II, Style 2

Locke#

M1172	USA0509201	1/2" CXC
M1173	USA0759201	3/4" CXC
M1174	USA1009201	1" CXC
M1175	USA1259201	1 1/4" CXC
M1176	USA1509201	1 1/2" CXC
M1177	USA2009201	2" CXC

Webstone Company, Inc. FULL PORT FORGED BRASS BALL VALVES WITH PLUGGED THREADED GAUGE HOLE - IPS



For water, oil or gas. Heavy forged brass body with a plugged 1/4" threaded hole for a pressure gauge. Hard chrome plated solid brass ball with Teflon® seats. (600 WOG/150 WSP) - ISO 9001

Locke#

M1118	41725	1 1/4" FIP valve
--------------	-------	------------------



EXPANSION RELIEF VALVE



3/4" Brass water heater ball valves with 125 Lb. P.S.I. Thermo expansion Relief Valve. Combination 1/2" Copper sweat & 1/2" threaded outlet fitting on relief valve.

Locke#

E0305 78-307RV 3/4" C X C Expansion Relief Valve

E0306 78-407RV 3/4" FIP X FIP Expansion Relief Valve



TEMPERA PRESSURE BALANCE VALVE



Guarantees a blend of mixed hot & cold water. Can be used with 2 handle valve assemblies, for greater consumer selection. Holds a selected water temperature to within 1°

regardless of pressure changes elsewhere in the supply lines. May be installed at any point on 1/2" water supply line at any angle or position. Water hammer arrestors are recommended.

Locke#

M0565 TRB-2 Tempera Pressure Balance Valve

SEALMASTER FORCE CUP PLUNGER



For general household use. Includes handle.

Locke#

M0715 5" Force Cup Plunger

FREE FLO 6" FORCE CUP PLUNGER



Preferred for all types of sinks, bowls & drains. Handle included.

Locke#

M0716 6" Free Flo Force Cup



THERMOSTATIC MIXING VALVE



Bronze body construction with 3/8 in. male compression connections, stainless steel disc, spring, and ball, copper thermostat.

It provides superior flow rate (between .5 and 2.5 gpm), accurate temperature control, and low pressure drop. It is suitable for kitchen and bath installations.

Maximum Pressure: 150psi
Accurate within +/-3°F
Temperature Range: 80°F to 120°F. ASSE 1016 listed.

Locke#

M1131 USGB Thermostatic Mixing Valve

Sioux Chief MINI-RESTER™ RESIDENTIAL WATER HAMMER ARRESTER



Locke#

M1930 660-TX2B 1/2" PEX crimp tee ASTM F 1807

M1730 660-TKB Female swivel ballcock nut x male ballcock thread tee

M1731 660-GTR1B 3/8 OD Female Comp tee **Lead Free**

Sioux Chief HYDRA-RESTER® COMMERCIAL WATER HAMMER ARRESTER



- ANSI/ASSE 1010-2004
- Factory tested to withstand 500,000 cycles (654-C tested)
- Allows for installation in 2 x 4 wall cavity
- Installs at any angle
- ASSE 1010 certified as a water hammer arrester that is "designed to provide continuous protection, without maintenance" allowing the Hydra-Rester to be installed without access panels

Locke#

M1727 652-AX 1/2" PEX crimp water hammer arrester, commercial



1/2" PEX BARB FITTING, RESIDENTIAL WATER HAMMER ARRESTOR



Locke#

M1720 MM-500PEX 1/2" PEX Water Hammer Arrestor



SWEAT ON WATER HAMMER ARRESTOR



Meets &/or exceeds performance requirements as set forth by the following standards: ANSI/ASME A112.26. 1M -1984 A.S.S.E. Stand. # 1010
COPPER SWEAT CONNECTION.

Locke#

M0563 SWA-500 1/2" Sweat

M0564 SWA-750 3/4" Sweat



WATER HAMMER ARRESTOR



All Precision Plumbing Products arrestors meet &/or exceed performance requirements as set forth by the following standards: ANSI/ASME A112.26. 1M -1984 A.S.S.E. Stand. # 1010

Locke#

M0560 1/2" Water Hammer Arrestor

M0561 3/4" Water Hammer Arrestor



WATER HAMMER ARRESTOR FOR LAUNDRY EQUIPMENT



3/4" Female hose thread x 3/4" male hose thread. Washers are included to insure a water tight seal. Original compact design.

Locke#

M0562 3/4" FHT x 3/4" MHT for laundry

M | MISCELLANEOUS

WATTS® AIR GAP FITTING (Required by Codes)



Locke#

M0998	909-AG-A 1/4" - 1/2" 009, 3/4" 009 M2
M0997	909-AG-C 3/4" - 1 1/2" 009/9091" - 1 1/2" 009M2, Air gap
M0996	909-AG-F 1 1/4" - 2" 009M1, OR 1" - 3" 009/909, Air gap

MAGIC-VENT™

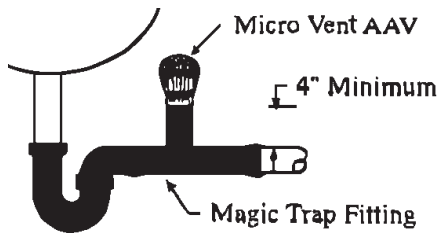

The fastest venting system to install. No need for additional piping to the outdoors.

Locke#

M0074	Magic Vent Micro 1-1/2" FIP
D0531	Magic trap 1 1/2" for M74 Vent



AUTOMATIC VENT

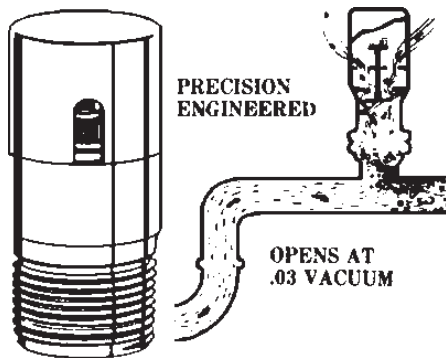

Locke#

M0098	1 1/2" Auto. Plumbing Vent
--------------	----------------------------



PLUMBING VENTING SYSTEMS

"MINI-VENT", "MAXI-VENT" and "REDI-VENT" Air Admittance Valves.

- No more vent pipes through the roof!
- No more roof flashings!
- Eliminates possible vent leaks!

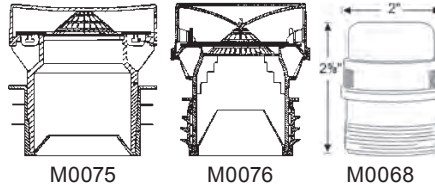

The **STUDOR Maxi-Vent®** offers the convenience of fitting any 2", 3", or 4" stack vent.

The **STUDOR Mini-Vent®** will fit any 1-1/4", 1-1/2" or 2" pipe at the fixture, eliminating the need for branch vents. **SBCCI** and **CABO** code approved and, in addition, both of these products have Product Listings with **BOCA (#92-46)**, **SBCCI (#9449)**, and **UPC**.

The **STUDOR Redi-Vent®** offers the convenience of fitting any 1 1/2", or 2" PVC pipe at the fixture, eliminating the need for branch vents. Code Approvals: (IPC), (SBCCI), (BOCA), (IRC), (UPC) Section 301.2. Listings: ASSE, (NSF Standard 14), (ASSE Standard 1051)

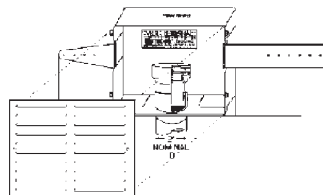

Recessed Box & Grille includes: Box, Grille, Label and Screws

Locke#

M0077	Recessed Box and Grille
M0075	Mini-Vent 1 1/4"-2"
M0076	Maxi-Vent 2"-4"
M0068	With PVC Connector 1 1/2"-2"



DWV SURE-VENT™



The Sure-Vent™ is a new air admittance valve certified to vent individual/multiple fixtures easily & reliably. It can withstand positive pressures up to 30 feet-of-head.

Locke#

M0073	1.25" - 2" dia. Sure-Vent™
--------------	----------------------------



Ayr-Filter™ ACTIVATED CARBON FILTER



Activated carbon filter that eliminates offensive odors from building vents and septic systems. The filter is easy to install and requires no special tools, permits,

or certifications.

- Installs easily on existing pipes
- Filter cartridge lasts up to 2-yr

Locke#

M1910	Activated Carbon Filter
M1911	Activated Carbon Replacement Filter for M1910



A4-MAX™ 500 DFu AIR ADMITTANCE VALVE



Air admittance valves (AAVs) are one way valves that allow air in, to vent or equalize pressure in waste pipes, without allowing gases, odors, or liquid out.

Ayrlett brand AAVs have been tested by an independent U.S. lab 500,000 cycles, in temperatures ranging from -40° to +150°F, without a single failure.

Locke#

M1928	500 DFU Air Admittance Valve
--------------	------------------------------



20 DFU AIR ADMITTANCE VALVE



Air admittance valves (AAVs) are one way valves that allow air in, to vent or equalize pressure in waste pipes, without allowing gases, odors, or liquid out. Ayrlett brand AAVs have been tested by

an independent U.S. lab 500,000 cycles, in temperatures ranging from -40° to +150°F, without a single failure.

Locke#

M1922	P-50 Solvent Weld valve
M1923	PT-300 Threaded valve
M1924	Outlet box with louvers & valve

M | MISCELLANEOUS

IPS

DUAL-DRAIN WASHING MACHINE BOXES

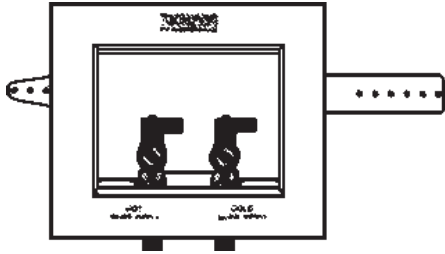

Prevents supply lines from crossing P-trap. 2" right & left drain couplings with knock-out test caps molded in box. Chrome 1/4" Turn Adapter Ball Valves Installed.

Locke#

L0549 82052 1/2" Sweat conx. Box

M0055 82054 1/2" CPVC conx. Box

M1155 82056 1/2" PEX Crimp Conx. Fits Vanguard & Durapex

M1152 89267 Washer Box Face Plate

IPS

CENTER DRAIN WASHING MACHINE BOXES

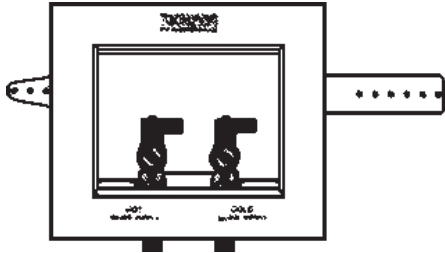

Extended mounting flange, unique box design. Chrome 1/4" turn adapter ball valves installed.

Locke#

M1156 82064 1/2" Sweat Conx. box

M1133 88221 Red 1/2" Sweat f **M1156**

M1134 88266 Blue 1/2" Sweat f **M1156**

M1158 82068 1/2" PEX crimp conx. box Fits Vanguard & Durapex

M1135 88222 Red 1/2" Valve f **M1158**

M1136 88227 Blue 1/2" Valve f **M1158**

M1152 89267 Washer box face plate

IPS

DUAL DRAIN WASHING MACHINE BOX

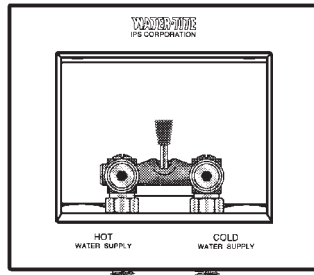

Features dual 2" PVC/ABS drain couplings with knock-out test caps & dual 3/4" condensate knockouts.

Locke#

M1151 85630 1/2" Sweat Conx.

Oatey

WASHER BOX (no valves)

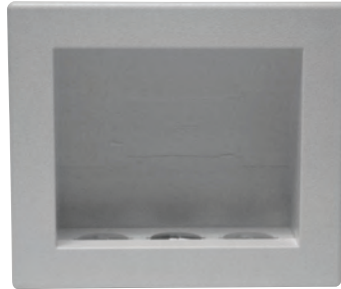

Locke#

L0540 38550 Washer Box (no valves)

WIRSBO

PEX VALVE OFFSET WASHING MACHINE OUTLET BOX

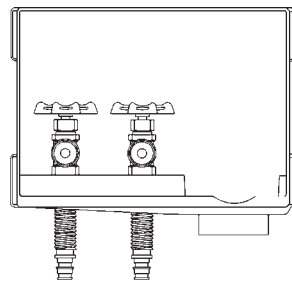

Offset Washing Machine Outlet box (plastic with brass valves). Use to connect 1/2" Wirsbo-PEX (Engel) to washing machine valves. Fits Wirsbo only.

Locke#

R1291 Offset Washing Machine Outlet with 1/2" fitting



OX BOX™

LEAD FREE PEX WASHER OUTLET BOX WITH WATER HAMMER ARRESTERS

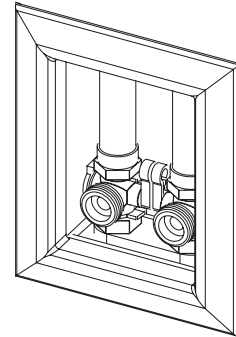

Boxes mount securely to a stud. Separates supply and drainage systems into two stud bays. Separate boxes offer flexible layout. Durable ABS stands up to job site abuse. Drain knockout is easy to remove with pliers.

Locke#

R1944 696-G2313WF 1/2" PEX F1960



OX BOX™

FRAMES



- Textured and paintable ABS
- Single frame for ice maker application
- Double frame for washing machine application easily splits for separated box installations

Locke#

M3150 696-1F Ox Box™ Single Frame

M3151 696-2F Ox Box™ Double Frame

Compare our prices and save!

M | MISCELLANEOUS

Why pay More?!



PLASTIC WASHER BOX WITH HAMMER ARRESTERS & DRAIN WIRSBO ProPEX Connectors

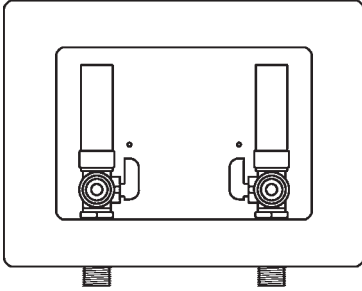

Integrated valve and arrestor design. Patented Hammer Arrestor design. One box does it all! Built-in test cap. Easy to install - adjustable face plate. Color coded hot and cold handles.

Locke#

M0063 OB-217 Washer box with hammer arresters with wirsbo valves



PLASTIC WASHER BOX WIRSBO ProPEX Connectors

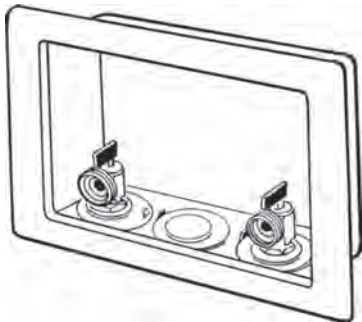

Patented box design provides left, center and right waste options. Built-in test cap in box. Adjustable faceplate accommodates up to 5/8" wall thickness. EZ-Turn Quarter-Turn Ball Valves made of durable brass resists cracking and corrosion and allows fingertip control of water flow. EZ-Turn valves have long-lasting o-rings and tough Teflon seats. Slim-line box profile allows for 1" backing

Locke#

M0064 OB-338 Plastic washer box WIRSBO ProPEX connectors

Thank You For Your Business!



WASHER BOX WITH 1/4 TURN VALVES WATER HAMMER ARRESTERS & PEX CONNECTIONS



Plastic washing machine box with Built-in test cap, Ayr-Lite™ water hammer arresters and Color coded 1/4 turn brass stop valves. Pex Connections

Locke#

M1916 Washing Machine Box With 1/4 Turn Stop Valves And Ayr-Lite™ Water Hammer Arresters PEX



OX BOX™ PEX WASHER OUTLET BOX

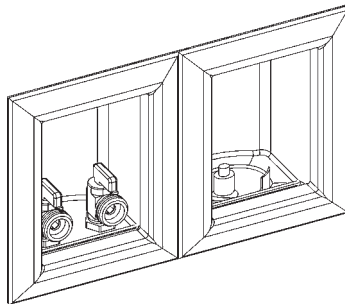

Boxes mount securely to a stud. Separates supply and drainage systems into two stud bays. Separate boxes offer flexible layout. Durable ABS stands up to job site abuse. Drain knockout is easy to remove with pliers.

Locke#

M1149 Pex Crimp F1807, Washer Box

R1631 Wirsbo ProPEX, Washer Box

-PASCO- WASHING MACHINE HOSE



Locke#

M0717 464 4' Washing Machine Hose

M0718 465 5' Washing Machine Hose

OnSite PRO Inc.



AUTOMATIC VALVE FOR WASHING MACHINES



Prevent water damage from flooding and leaking washing machines. This washing machine leak detector will detect a leak, sound an alarm, and automatically turn off the water supply to the washing machine to prevent further damage.

This water detection unit can be easily installed in about 10 minutes.

Comes with a One Year warranty.

Components: 90 Degree Motorized Ball Valves (Two valves, 3/4 inch Hose Threaded with union), Water/Leak Sensor, AC Power Adaptor.

Locke#

E0632 FS3/490 FloodStop Valves for Washing Machines (Two 90° 3/4" Hose Valves)

E0630 FS3/4WH FloodStop Valve (1) for Water Heaters 3/4" threads

E0631 FS1-1/4NPT FloodStop Valve (1) for Water Heaters 1 1/4" Threads

-PASCO- WASHER DRAIN HOSE



Can be cut at any section to fit 3/4", 7/8" or 1" drain.

Locke#

M0720 486 5' Universal Drain Hose

BrassCraft® SPEEDI-PLUM PLUS™ BRAIDED CONNECTORS



Locke#

M0722 BL12-48WA 48" Stainless Steel Washing Machine Hose

M0723 BL12-60WA 60" Stainless Steel Washing Machine Hose

M0698 B0-12IM 1/4" comp x 12" comp x 12" valve to icemixer

M0699 B0-72IM 1/4" comp x 72" filter to icemaker

Ayrlett
company

ICE MAKER BOX WITH 1/4 TURN VALVE AND WATER HAMMER ARRESTER & PEX CONNECTIONS



Plastic icemaker box with Ayr-Lite™ water hammer arrester, 1/4 turn brass stop valves. Pex Connections

Locke#

M1921 Icemaker Box With 1/4 Turn Stop Valve And Ayr-Lite™ Water Hammer Arrester. Pex conn

Oatey

ICE MAKER BOX

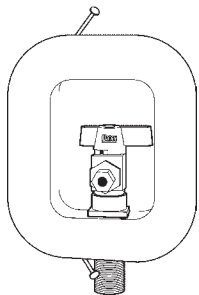

1/4 Turn Brass Ball Valve. Copper sweat. Dimensions: Box, 3.20" W x 4.15" H x 2.35" D; Faceplate, 5.00" W x 5.89" H x .50" D. Nails preloaded.

Locke#

M1159 I2K Icemaker Box

WIRSBO PEX VALVE ICE MAKER OUTLET BOX

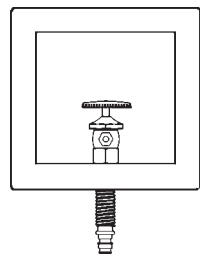

Ice Maker Outlet Box (plastic with brass valves). Use to connect 1/2" Wirsbo-PEX (Engel) to ice maker valve. Fits Wirsbo only.

Locke#

R1292 Ice Maker Outlet Box with 1/2" ProPEX fitting

LSP
PRODUCTS GROUP

MINI ICEMAKER BOX WITH HAMMER ARRESTER WIRSBO ProPEX or MIP

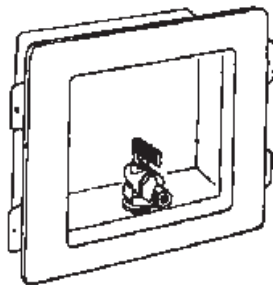

- Rounded corners and compact size provide a contemporary look.
- Molded from high impact plastic
- Includes captive nails for easy installation
- Adjustable faceplate accommodates up to 5/8" wall thickness
- Quarter-turn brass ball valves

Locke#

M0066 OB-814 Icemaker box ProPEX

Sioux Chief
OX BOX™

LEAD FREE PEX ICE MAKER OUTLET BOX WITH WATER HAMMER ARRESTER

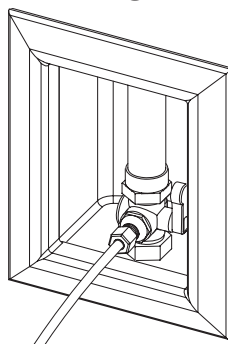

Boxes mount securely to a stud. Separates supply and drainage systems into two stud bays. Separate boxes offer flexible layout. Durable ABS stands up to job site abuse. Drain knockout is easy to remove with pliers.

Locke#

R1945 696-G1010WF 1/2" PEX F1960

IPS

ICE MAKER BOX

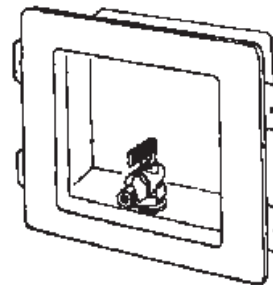

Complete brass valve assembly, (1/2" nom. copper inlet x 1/4" OD copper outlet). Sturdy faceplate & 4 screws. Chrome 1/4" Turn Adapter Ball Valves Installed.

Locke#

M0054 82088 1/2" MIP/Sweat conx. box

M0056 82090 1/2" CPVC conx. box

M1154 82092 1/2" pex crimp conx. box Fits Vanguard & Durapex

M1153 89266 Icemaker box face plate

Sioux Chief

ICE MAKER OUTLET BOX

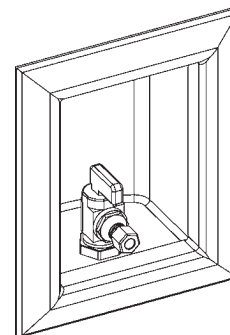

Can be used where necessary in plumbing supply systems. Box allows for mounting with supply line from top or bottom on-stud or between studs. Box made of ABS. Bracket made of galvanized steel. Valve body made of Cast brass. Listed by UPC/IAPMO to meet UPC Conforms to IPC

Locke#

M1150 Pex Crimp F1807, Ice Maker Box

R1632 Wirsbo ProPEX, Ice Maker Box

M1171 1/2" Female Sweat, Ice Maker Box

M | MISCELLANEOUS



OX BOX™

DISHWASHER/TOILET OUTLET BOX



- Strong installation, mounting on stud
- Integral nail holes offer quick installation
- Bracket track allows for adjustment between studs
- Durable ABS stands up to job site abuse
- Flip box for top supply
- High-quality quarter-turn ball valve(s)
- 3/8" O.D. Compression outlet connection(s)

Locke#

R1634 1/2" F1960 Dishwasher/Toilet Outlet Box For Wirsbo Pex

M1178 1/2" F1807 Dishwasher/Toilet Outlet Box For Crimp Pex



DISHWASHER CONNECTOR KIT



Kit contains:

- (1) 3/8 in. comp. x 3/8 in. comp. stainless steel dishwasher connector - 72 in. length
- (1) 3/8 in. comp. x 3/4 in. hose fitting
- (1) 3/8 in. comp. x 3/8 in. MIP fitting

Locke#

M0649 Dishwasher connector kit



DISHWASHER HOSE FITTING



Locke#

M1179 A-158A 3/8 in. Comp x 3/4 in. Female Hose

BrassCraft® QUICK CONNECT DISHWASHER KIT

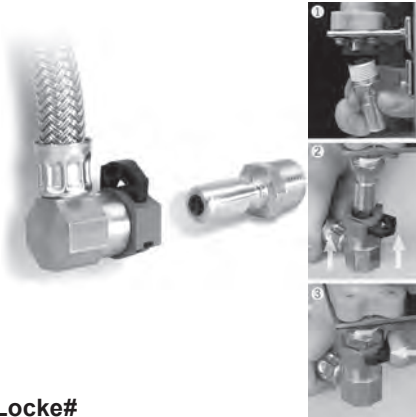

Locke#

M0629 72" Quick connect dishwasher kit with hose

BrassCraft® BRAIDED DISHWASHER CONNECTORS



Locke#

B0209 12" x 3/8" Comp x 3/8" Comp

B0210 16" x 3/8" Comp x 3/8" Comp

B0211 20" x 3/8" Comp x 3/8" Comp

M0707 B1-12DW6D 3/8" x 3/8" x 72" dishwasher connector

GENE RICH AND COMPANY BULK DISHWASHER DRAIN HOSE



Locke#

M0719 A220 5/8" ID x 50' Black Hose

M0876 A218 7/8" ID x 50' Black Hose

TBP DISHWASHER DISPOSER CONNECTOR



Locke#

M0655 Dishwasher/Disposer connector



OUTLET BOX WITH 20 DFU AIR ADMITTANCE VALVE AND LOUVERED COVER

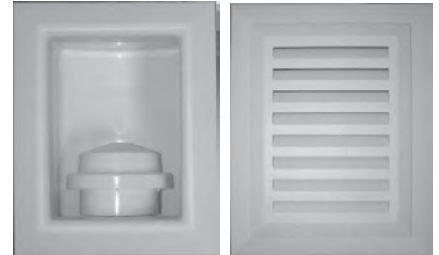

The Ayrlett® AAV box from comes with your choice of a PVC or ABS 20 DFU air admittance valve mounted in a utility box ready to install. The box also comes standard with a 1 1/2" - 2" adapter, a protective plastic cover to prevent debris from entering the vent during installation, and a sturdy louvered cover.

Locke#

M1924 Outlet Box With 20 Dfu Air Admittance Valve And Louvered Cover



OX BOX™

LAVATORY OUTLET BOX

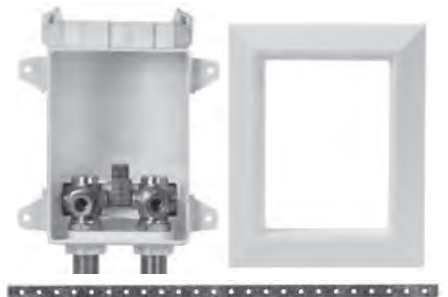

- ABS boxes mount securely to stud
- Allows for straight and secure supply stops recessed into the wall
- Eliminates backbreaking labor of cleaning stub outs and installing supply stops
- Debris covers included to protect boxes from drywall mud and paint
- High-quality quarter-turn ball valves with 3/8" O.D. compression outlet connections

Locke#

M1168 1/2" PEX F 1807 Lavatory Box

R1633 1/2" PEX F 1960 Lavatory Box

M | MISCELLANEOUS



FLOOR & CEILING PLATES



Heavy pattern. 2 holes. Polished chrome plate finish.

Locke#

M0027 1/2" IPS F&C Plate

M0029 1/2" CWT F&C Plate

M0028 3/4" IPS F&C Plate

M0023 3/4" CWT F&C Plate

M0030 1 1/4" IPS F&C Plate

M0031 1 1/2" IPS F&C Plate

M0032 2" IPS F&C Plate



WHITE ESCUTCHEONS

White Plastic, Shallow.



Locke#

M1405 RXEW3 Plastic escutcheons for 1/2" plastic tube

GENE RICH AND COMPANY CHROME DEEP-BOX ESCUTCHEONS



Locke#

M1403 1 1/4" chrome plated Escutcheon

M1404 1 1/2" chrome plated Escutcheon

M1409 1 1/2" white plastic Escutcheon

GENE RICH AND COMPANY CHROME DEEP BELL ESCUTCHEONS



Sure-Grip Type (IPS),

Locke#

M0025 1 1/4" OD Escutcheons

M0026 1 1/2" OD Escutcheons

TBP SHALLOW ESCUTCHEONS



Locke#

M0015 3/8" chrome plated Escutcheon

M0016 1/2" chrome plated Escutcheon

M0017 3/4" chrome plated Escutcheon

M0018 1" chrome plated Escutcheon

M0019 1 1/4" chrome plated Escutcheon

M0020 1 1/2" chrome plated Escutcheon

M0021 2" chrome plated Escutcheon

M0022 5/8" OD for 1/2" copper

M0024 7/8" OD for 3/4" copper



INSPECTION DOOR

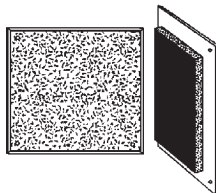

- No framing or skilled carpentry required.
- Can be painted / wallpapered to become virtually invisible.
- Insulated for energy & noise efficiency.

Locke#

M0920 10" x 10" Inspection Door

M0921 16" x 18" Inspection Door



E-Z ACCESS® II PANEL

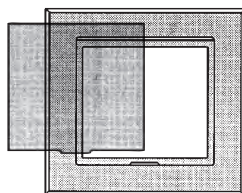

A sturdy frame & removable panel of durable plastic, which has a textured finish that allows you to paint it to match your decor. The frame

can be secured to the wall with adhesive or with fasteners, & has beveled edges that give it a flush appearance. The panel is easily removed by simply lifting up & out. Since there are no clips, hinges, or springs to break or fail, E-Z Access assures you no hassle access for years to come.

Locke#

M1902 EZ080080 5" x 5" opening

M0917 EZ080080 8" x 8" opening

M0922 EZ120120 12"x12" opening

M0918 EZ140140 14"x14" opening

M0924 EZ140260 14"x26" opening

STRIKE GUARD™

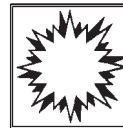

Wall Protector Prevents & Conceals Wall Damage Peel & stick application can be painted or wallpapered

Locke#

M0919 5" x 5" Strike Guard

WATTS® SPRINGFIT ACCESS PANELS



It consists of a wall-mountable panel that can be painted or wallpapered. It is available in two sizes to fit any size shape hole from 5in.x6in. to 15in. x15in.

Locke#

M1217 APU9 9" x 9"

M1218 APU15 15"x15"



ROCK ENCLOSURE



Dimensions: 27"L x 21"W x 25"H
Common Uses:
Well - 8" Diameter up to 24"H
Irrigation Valve (Backflow Device)

20"H x 20"L x 2" pipe width

Locke#

M1288 102FS Rock Enclosure



INSULATED POUCH



24"L x 24"H. Pouch can be placed over pipes to protect from the cold. Compatible with Models 101, 102, and 110. Two years UV protection when used without an enclosure. R-13 Value.

Locke#

M1289 602GN Insulated Pouch

ECONOMY FREEZE CAP

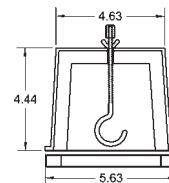

Insulates outdoor faucets

Locke#

M0524 PFC-2 3" Insulator

M | MISCELLANEOUS

Oatey

POLYETHYLENE SHOWER PAN LINER



Used for shower pans, floor drain flashings and concealed waterproofing. Accepted by FHA and HUD.

Locke#

M0415 6'x50' Polyeth. Shower Liner

M0417 5'x40' Polyeth. Shower Liner

SHOWER PAN LINER CEMENT



Locke#

M0418 16 oz. Shower Pan Liner Cement for **M0417**

-PASCO- PRE-FAB CORNERS



Flush dam corner. Use where a flat wall or stall backing board meets a dam at a 90° angle.

Locke#

M1901 Flush dam corner

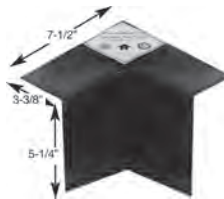

Top Dam Corner Use where a wide 90° top corner of a two dam stall or roman tub meet.

Locke#

M1903 Top dam corner

PLASTIC BACKWATER VALVE



Usually used in floor drains. Prevents backflow or flooding if drain lines get stopped up. 2" MIP.

Locke#

M0547 2" Plastic Backwater Valve

MASTER WATER METER



Locke#

M4545 5/8" x 3/4" Master Water Meter (Gallon readout)

M4547 1" Master Water Meter (Gallon readout) Less Couplings

A.Y. McDonald Mfg. Co.

COPPER METER SETTERS - SERIES 22

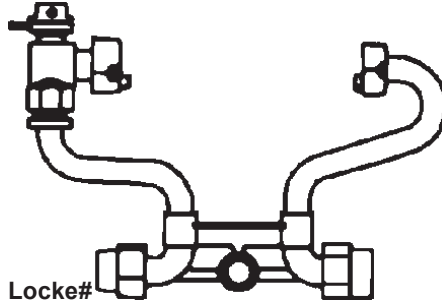

Locke#

M4531 22-207WX22 33 5/8" x 3/4", 7" high meter setter with Mac Pak 3/4" CTS Tube Compression

M4532 20-207WXDD-33 5/8" x 3/4", 7" high, valve x swivel nut, 3/4" CTS tube compression inlet and outlet.

M4533 22-207WX23 44 1" CTS x 1" IPS, 7" m.s. with Mac Pak 1" CTS Comp. x 1" IPS Poly Comp.

M4534 22-410WX22 44 1" CTS x 1" IPS, 10" m.s. with Mac Pak 1" CTS Comp. x 1" IPS Poly Comp.

A.Y. McDonald Mfg. Co.

METER FITTING GASKET/ WASHER



Locke#

M4505 4124-281 3/4" Leather Gaskets

M4506 4124-282 1" Leather Washers

M4510 4124-240 3/4" Rubber Gaskets / Washers

M4511 4124-248 1" Rubber Gaskets / Washers

(Please order meter nipples and washers separately.)

A.Y. McDonald Mfg. Co.

TEE CONNECTION CTS x CTS x CTS

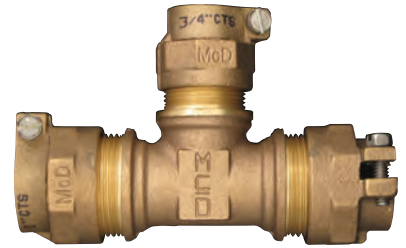

Locke#

M4562 4760-22 1x3/4" Tee Connection CTS x CTS x CTS

A.Y. McDonald Mfg. Co.

COPPER METER SETTERS - SERIES 21

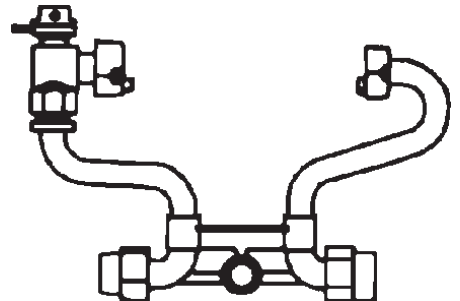

T Comp. or 3T Comp. - bottom inlet/outlet, Angle Ball Valve - top inlet, Meter Nut - top outlet

Locke#

M4563 21-207WXTT-33 5/8x3/4 Meter, 7" height Basic setter

A.Y. McDonald Mfg. Co.

COUPLING CTS X MIP

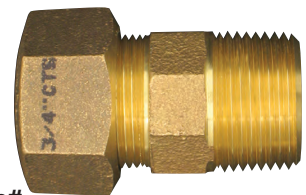

Locke#

M4564 4753T 3/4"x1" Coupling CTS X MIP

M4565 4753T 3/4" Coupling CTS X MIP

M4566 4753T 1" Coupling CTS X MIP

A.Y. McDonald Mfg. Co.
WATER SERVICE BRASS
METER STOPS

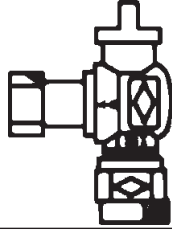

Locke#	
M4501	4602T 1" Angle Meter Stop

A.Y. McDonald Mfg. Co.
STRAIGHT METER
COUPLING

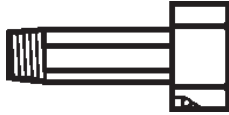

Locke#	
M4539	4624 3/4" Swivel x MIP Coupling
M4540	4624 1" Swivel x MIP Coupling

A.Y. McDonald Mfg. Co.
1/4" BEND METER
COUPLING

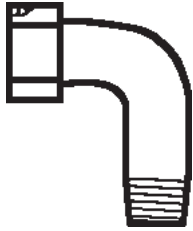

Locke#	
M4536	4621 3/4" Swivel x MIP Coupling
M4537	4621 1" Swivel x MIP Coupling

A.Y. McDonald Mfg. Co.
METER ELBOWS

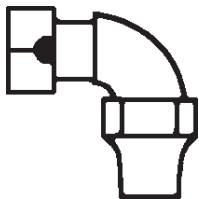

Locke#	
M4503	4783S 3/4" Flare Meter Elbow
M4542	4783S-22 3/4" "22" CTS Comp. Meter Elbow
M4507	4783ST 1" "T" INC FNPT Swivel x Comp.

(Please order meter nipples and washers)

A.Y. McDonald Mfg. Co.
MALE ADAPTER

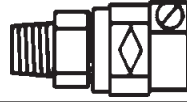

Locke#	
M4517	4753-22 3/4" MIP x Mac Pak
M4518	4753-22 3/4" x 1" Mac Pak x MIP
M4519	4753-22 1" CTS x MIP Adapter
M4520	4753-22 1" Mac Pak x 3/4" MIP

A.Y. McDonald Mfg. Co.
COUPLING

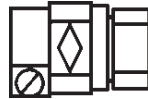

Locke#	
M4529	4754-22 3/4" Coupling CTS x FIP
M4543	4754-22 1" Coupling CTS x FIP
M4544	4754-22 1" CTS x 3/4" FIP Coupling

LA CO.
SQUARE KEY ROD

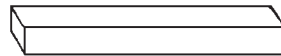

Locke#	Price per 10'. Do not cut.
H0750	3/8" x 10' Square Key Rod

A.Y. McDonald Mfg. Co.
CORPORATION STOP

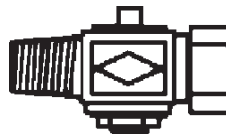

Locke#	
M4516	4701-22 1" AWWA x Mac Pak CTS Comp.
M4556	4701 3/4" AWWA x 3/4" Flare Corporation Stop

A.Y. McDonald Mfg. Co.
BRASS RELIEF VALVE



Locke#	
M4559	6214 1/2" Brass Relief Valve, 180°F max. temperature
M4558	6214 3/4" Brass Relief Valve, 180°F max. temperature

A.Y. McDonald Mfg. Co.
THREE PART UNION



Locke#	
M4522	4758-22 3/4" CTS Compression
M4523	4758-2244 3/4" CTS Compression x PVC Compression
M4524	4758-22 1" CTS Compression
M4525	4758-2244 3/4" CTS Compression x PVC Compression
M4535	4758-2244 3/4" CTS Compression x 1" CTS Compression
M4528	4758-2244 1" CTS Compression x 1" PVC Compression

A.Y. McDonald Mfg. Co.
BALL CURB STOP



Locke#	
M4526	6102-22 3/4" CTS Curb Stop x FIP
M4527	6102-22 1" CTS Curb Stop x FIP

A.Y. McDonald Mfg. Co.
DOUBLE STRAP SADDLES
WITH AWWA OUTLETS

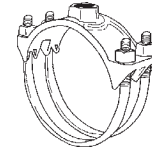

Locke#	SERIES 3825
M4550	6"x3/4" AWWA Double strap saddle
M4551	6"x1" AWWA Double strap saddle

CARSON INDUSTRIES LLC
VALVE BOX WITH LID

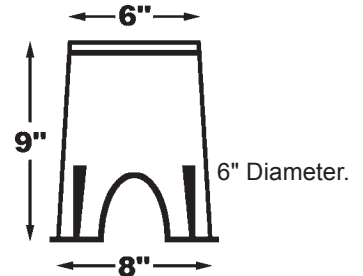

Locke#	
M0785	6" Diameter Valve Box with lid
R2121	6" Diameter Lid for M0785

M | MISCELLANEOUS

KOHLER KOHLER TANK GASKET

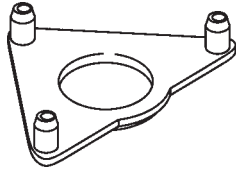

Locke#
M0691 51487 Kohler Tank Gasket

KIRK HILL INC. THREADED CONE WASHERS



Locke#
M0663 W-288 1/2" Cone Washers

SLIP SEAL Radiator Specialty Company 1 1/2" SINK CONNECTION WASHERS



Locke#
M0674 1 1/2" Cloth Insert Washer

FLANGED SPUD WASHERS



Locke#
M0705 1 1/2" Flanged Spud Washer
M0706 2" Flanged Spud Washer

TANK-TO-BOWL GASKET

3 1/4" x 2 1/4"



Locke#
M0703 Solid Tank-to-Bowl Gasket

-PASCO- TANK-TO-BOWL GASKET



Sponge Rubber Fits
American Standard and
current Crane models

Locke#
M0662 Tank-to-Bowl Gasket

DRIP-FREE SLIPJOINT WASHER

25 per bag



Locke#
M0694 1 1/4" Drip-Free Slip Joint
Washer
M0695 1 1/2" Drip-Free Slip Joint
Washer

DRIP-FREE TAILPIECE WASHER

25 per bag



Locke#
M0696 1 1/2" Drip-Free Tailpiece Washer

FLANGED TAILPIECE WASHER



Locke#
M0675 1/2" Flanged Dishwasher
Tailpiece Washer

GRAPHITE STEM & VALVE PACKING BLISTER CARD



Locke#
M0088 1/8" Graphite stem and valve
packing blister card

MACK GASKET



Locke#
M0702 G-1A 1 1/4" ID, 2" OD Gasket

WASTE & OVERFLOW WASHER



Locke#
M0704 2 3/8" waste & overflow washer

KIRK HILL INC. FLUSH VALVE SHANK WASHER



Locke#
M0700 2 1/4" ID Flush Valve Washer

Fluidmaster Inc. TANK-TO-BOWL GASKET



Fits most close-coupled
toilets. Universal fit for both
round and hex-shaped flush
valve nuts. Sponge rubber
material.

Locke#
M0673 6100 Tank-to-Bowl Gasket

Sioux Chief MANUFACTURING COMPANY, INC. AMERICAN STANDARD TANK BOWL KIT



1 1/8" High recessed
gasket with Deluxe
brass tank to bowl
bolts.

Locke#
M4014 490-10560 Tank Bowl Kit

CONE WASHER



Step design cone washer for 3/8" lavatory &
sink supply.

Locke#
M0660 3/8" Sink & Lavatory
M0661 3/8" Closet Supply

BrassCraft® WASHERS (FLAT)



Carton quantity-10 carded
Locke#
M4000 75-151 Assorted Sizes,
neoprene. 7 flat, 2 screws

M MISCELLANEOUS

BrassCraft® ASSORTED "O" RINGS

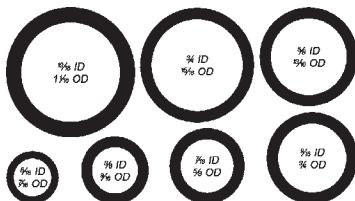

Made of high quality rubber. Comes in seven most popular sizes.

Carton Quantity-10, 7 per card

Locke#

M4012 75-220 "O" Rings

"O" RINGS



Locke#

M0690 100 Assorted O Rings of the most popular sizes

M0692 "O" rings - 100

Fits fixtures made by: American Standard, Arrowhead, General Brass, Gerber, Harcraft Globe, Milwaukee, Reocal, Savoy Chase, Cons. Brass, Gopher, Price-Pfister, Sterling. 3/8" ID, 9/16" OD, Wall 3/32".

CUT SLIP-JOINT WASHERS

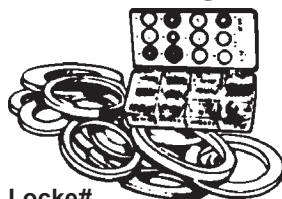

Grey rubber. All packed 100 per box. Heavy wall. 3/16" thick.

Locke#

M0670 1 1/4" Cut Slip-Joint Washer

M0671 1 1/2" Cut Slip-Joint Washer

M0664 1 1/2" x 1 1/4" cut slip-joint washer

M0672 2" Cut Slip-Joint Washer

-PASCO- BRASS FRICTION RINGS

Sold 100 in a pack.



Locke#

M0665 29/64" ID x 21/32" OD, 3/8" tube size for Lavatories

M0666 25/64" ID x 13/16" OD, 3/8" tube size for Closet

KIRK HILL INC.

FAUCET & BALLCOCK SCREW ASSORTMENT



Assortment consists of 100 pieces packed in screw top can. Solid brass faucet screws, nickel-plated eccentric and handle screws, brass thumb screws, and plated cotter pins for ballcocks.

Locke#

M0688 100 Assort. Ballcock Screw

GENE RICH AND COMPANY SLIP JOINT NUTS



Locke#

M0008 1 1/4" x 1 1/4" Slip Joint Nut

M0009 1 1/2" x 1 1/2" Slip Joint Nut

M0010 2" x 2" Slip Joint Nut

M0011 1 1/2" x 1 1/4" Slip Joint Nut

M0014 Brass 1 1/2" x 1 1/2" Slip Joint Nut

FAUCET WASHERS



Made of specially compounded neoprene for resistance to hot or cold water. Packed in plastic boxes.

Locke#

M0676 200 Beveled washers

M0685 200 Flat Washers

Sioux Chief MANUFACTURING COMPANY, INC. SBR FLAT BIBB WASHERS



SBR (synthetic blended rubber)

Locke#

M1650 291-30125 150 assorted washers with six 10-24 screws

M1651 291-30126 270 washers with snap-in chrome wire holders

Sioux Chief MANUFACTURING COMPANY, INC.

SBR BEVELED BIBB WASHERS

SBR (synthetic blended rubber)



Locke#

M1652 291-30225 150 assorted washers with six 10-24 screws

M1653 291-30226 170 washers with snap-in chrome wire holders

20 PIECE BIBB WASHER & SCREW ASSORTMENT



Neoprene washer and screw assortment. Contains 20 assorted flat neoprene washers and 4 solid brass screws in a plastic box.

Locke#

M0684 20 Piece Washers & Screws

BIBB WASHERS



Locke#

M0861 Assorted Beveled Washers

BULK WASHERS

Locke#

M1610 00 Beveled Faucet 100 Pack

M1611 1/4" Beveled Faucet 100 Pack

M1612 1/4" L Beveled Faucet 100 Pack

M1615 3/8" L Beveled Faucet 100 Pack

Locke#

M1617 00 Flat Bibb 100 pack

M1618 0 Flat Bibb Washers 100 Pack

M1619 1/4" Flat Bibb Washers 100 Pack

M1620 1/4" Flat Bibb Washers 100 Pack

M1623 1/2" Standard Flat Bibb 100 Pack

-PASCO- CONE FILTER WASHER

Fits 3/4" FHT.

Locke#

M0697 2244 Cone Filter Washer



BASIN-BATH STOPPER

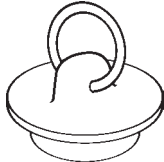

High quality white synthetic rubber, solid base, with nickel plated ring attached.

Locke#

M0708 418A 1-13/8" Multi-Fit Stopper

GENE RICH AND COMPANY

1 1/2" BATH STOPPER

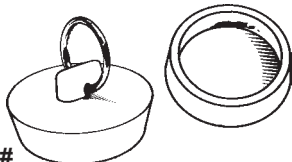

Locke#

M0709 S-104 1 1/2" Stopper

BrassCraff®

BRASS HOSE CAP



1 per card. 3/4" female hose thread, with washer.

Locke#

M4021 PS2705 Brass

GENE RICH AND COMPANY

GARDEN HOSE ADAPTER



For 15/16 dia. faucet. With 15/16-27 female or 55/64-27 male thread. Adapts to 3/4" male garden hose thread.

Locke#

M4022 A01-040 Chrome



Radiator Specialty Company

10 PIECE GARDEN HOSE WASHER KIT



Locking tabs insure snug, leakproof fit. Unique package keeps washers from getting lost. User simply tears off washers as needed.

Locke#

M0721 12Pc. Vinyl Hose Washer kit

3M

PLASTIC CODE TAPE

For wrapping steel pipe.



Locke#

M0085 2" x 100 Ft. Black Code Tape

-PASCO-

YELLOW TEFLON® GAS LINE TAPE



Eliminates pastes and dope on all material! For threads less than 1 1/2".

Locke#

M0744 1/2" x 260" yellow Teflon gas tape

WHITE TEFLON TAPE



Locke#

M0760 1/2" x 260" Teflon Thread Tape

M0743 3/4" x 520" Teflon Thread Tape

Oatey®

PINK TEFLON TAPE



Use on metal or plastic threads. Provides fast positive seal.

Locke#

M1113 1/2" x 260" Teflon Thread Tape



BLUE PTFE THREAD TAPE



- A new, thicker, professional-grade
- Monstrous roll (1429")
- Seals threads in more applications
- No need for pipe dope.
- Easier to use - no waste!
- All purpose - use on iron, brass, copper, aluminum, stainless steel, galvanized steel, polyethylene, polypropylene, PVC, CPVC, ABS, fiberglass and more.

Locke#

M1115 1/2" x 1429" PTFE thread tape

M1116 3/4" x 1429" PTFE thread tape

M1117 1" x 1429" PTFE thread tape

FERNCO

POW-R WRAP PIPE REPAIR

Water Activated Fiberglass Wrap



FAST AND EASY TO INSTALL

Pow-R Wrap is a strong, *permanent* and economical repair. Works on wet, dry, clean, dirty or corroded pipes. Even works under water... salt or fresh.

PERFECT FOR REPAIRING:

- Copper
- Rubber
- Concrete
- Plastics
- Fiberglass
- PVC Pipe
- Galvanized
- And MORE!

IDEAL FOR ALL FLUID BEARING PIPES AND HOSES:

- Water
- Sewage
- Air
- Steam
- Fuel
- Hydraulics

STRUCTURAL REPAIRS TO:

- Brackets
- Mufflers
- Fencing
- Supports
- Exhaust Pipes
- Tools

EACH KIT CONTAINS:

- Resin impregnated fiberglass tape in foil bag
- Epoxy putty to enhance repairs
- 1 pair of protective gloves
- Complete installation instructions

Non-Toxic Contains no harmful solvents. Can be used on water and food service lines.

Locke#

M1114 Pow-R Wrap 2" x 4'

M

MISCELLANEOUS



ALUMINUM OXIDE OPEN MESH ABRASIVE



- 21 x 21 Mesh – Has larger holes than other open mesh products. This feature prevents “loading” and allows contractors to rinse the mesh clean. Resists clogging even when used on softer materials.
- Premium blended 165 grit white Aluminum Oxide cuts and scores surfaces faster for more effective cleaning and deburring. Traditional open mesh plumbers’ rolls typically use less aggressive grit material.
- Waterproof – Wet conditions have absolutely no adverse effect on the performance or durability of Blue Monster open mesh.
- 2" Width – 33% wider than traditional 1-1/2" wide plumbers’ rolls. Blue Monster provides contractors with more “surface-to-surface” coverage.
- Bright Blue color – Bright color makes it easy to find in dark or low-light work spaces.

Locke#

M1410	70151	2" x 8" mini strips
M1411	70152	2" x 5 yard roll
M1412	70154	2" x 10 yard roll
M1413	70156	2" x 25 yard roll

SAND CLOTH

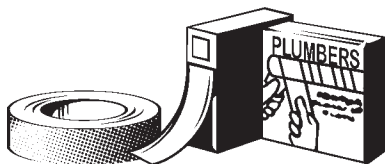

To clean copper tubing before soldering.

Locke#

M0093	1 1/2" x 30'	Open Nylon Mesh
M0095	1 1/2" x 30'	Fine Sand Cloth

FITTING BRUSHES

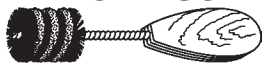

Locke#

M0096	1/2"	Copper Fitting Brush
M0097	3/4"	Copper Fitting Brush
M1090	3/8"	Stainless Steel Brush
M1093	3/4"	Stainless Steel Brush
M1094	7/8"	Stainless Steel Brush
M1096	1 1/8"	Stainless Steel Brush



ULTRA-FLEX® ABRASIVE CLOTH



- Super flexible Ultra-Flex® backing conforms to tight work areas. Blue Monster is unlike any other sand cloth. You can actually feel the difference.
- Premium 150 grit cuts and scores surfaces faster for more effective cleaning and deburring. Traditional plumbers’ rolls typically use less aggressive grit material.
- 100% Waterproof – Wet conditions have absolutely no adverse effect on the performance or durability of Blue Monster abrasive cloth.
- 2" Width – 33% wider than traditional 1-1/2" wide plumbers’ rolls. Blue Monster provides contractors with more “surface-to-surface” coverage.
- Bright Blue color – Bright color makes it easy to find in dark or low-light work spaces.

Locke#

M1415	70171	2" x 8" mini strips
M1416	70172	2" x 5 yard roll
M1417	70174	2" x 10 yard roll
M1418	70176	2" x 25 yard roll



POWER-DEUCE BRUSHING TOOL



2 brushes in 1, the fitting brush cleans the inside diameter & the tube cleaning brush cleans the outside diameter. It can also be used as a hand tool. It has a self-cleaning brush with rust-proof, stainless steel bristles. Recommended use with T654 or T1230 Quick Change Adapter.

Locke#

M1371	1/2" ID	Power Deuce Brushing
M1373	3/4" ID	Power Deuce Brushing



CLEANFIT PLUMBER'S 4-IN-1 COPPER TOOL



Quality tube cleaning and fitting brushes cut faster and make solder joints last longer. 1/2" x 3/8" ID

Locke#

M0101	4-In-1	Plumber's Copper Tool
M0102	Replacement Kit for M101	Contains replaceable tube & fitting brushes.



METAL ACID BRUSH

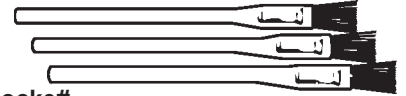

Locke#

M0094	3/8"	Metal acid dope brush
--------------	------	-----------------------

We Do More Than Just Meet our Competition, We Beat Them. Compare our prices and save!!

M MISCELLANEOUS

CANFIELD TECHNOLOGIES
WIRE SOLDERS

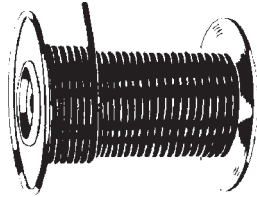

Locke#

M0425 1 Lb. - 50/50 Wire Solder

M0427 1 Lb. - 95/5 Wire Solder

CANFIELD TECHNOLOGIES
**100% WATERSAFE
 SOLDER**

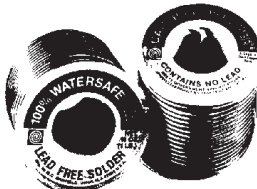

- Patented
- Flows like 50/50
- Meets all Federal requirements
- Bridges gaps in loose fittings
- 20% more lineal ft. of wire solder
- Requires about 1/2 the labor time
- Works well with almost any flux paste or liquid. Water Safe.

Locke#

M0424 50 Lead Free Solder-1Lb.

CANFIELD TECHNOLOGIES
ACID CORE SOLDER

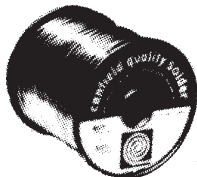

Activated organic acid providing fast flow on moderately hard-to-solder metals. The after-soldering residue is noncorrosive. 1 lb. spool, 40/60.

Locke#

M0428 1 Lb. Spool Acid Core Solder

CANFIELD TECHNOLOGIES
FLOSAFE



Bulk tensile strength of 6,200 p.s.i., lead-free solder. Working range from 441-590°F. 97% tin, 3% copper.

Locke#

M0421 1Lb. Lead free solder, .125 dia.

HARRIS
SILVER STAY BRITE®

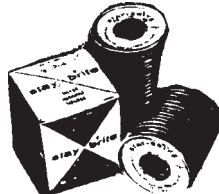

LEAD FREE

Locke#

M0423 #1 Roll Silver Stay Brite, 1/8" diameter 4% silver solder

M0420 #1 Roll Silver Stay Brite-8, 1/8" diameter 6% silver solder

HARRIS
BRAZING ROD



Brazing Alloys, 28 stick package. 1/8"x .050"

Locke#

M0429 5% Silver Solder, 28 sticks

M0430 0% Silver Solder, 28 sticks

M0431 2% Silver Solder, 28 sticks

M0432 6% Silver Solder, 28 sticks

M0434 15% Silver Solder, 28 sticks

*We appreciate
 Your
 Business!*

Just-For-Copper™
**SOLDERLESS COPPER
 BONDING**
**NEVER HOT SOLDER COPPER
 AGAIN!**



- Rated at 500psi
- Fast! - up to 80% faster than hot soldering
- Not Flammable
- Odorless, tasteless and non-toxic
- Safe for drinking water
- Bonds all copper and brass pipes and fittings
- 100% Leak free bond every time

Locke#

M1380 10g Just-For-Copper™

M1381 50g Just-For-Copper™

LACO.
**ALUMINUM FLUX PASTE
 & SOLDER REPAIR**



Repair kit for professional repairmen. For aluminum evaporators, ducts, tubing. Also solders aluminum to copper.

Locke#

M0887 Flux Paste & Solder Kit

M
MISCELLANEOUS

SOLDERING FLUX

HARRIS BRIDGIT® SOLDER & PASTE FLUX



Active to 800°F. At soldering temp., Bridgit flux will not burn, reducing black carbon formations that can cause voids that result in leaks.

Locke#

M0891 4oz. Bridgit Flux Paste

M0422 1Lb. Bridgit Lead Free Solder

HARRIS STAY-SILV® WHITE FLUX



BRAZING FLUX

Locke#

M0828 40022 6.5 oz. Flux Stay-Silv

HARRIS STAY-CLEAN® LIQUID SOLDERING FLUX



Locke#

M0827 40002 4 oz. Flip Top

CANFIELD TECHNOLOGIES COPPERMATE FLUX



Cleans & prepares metal surfaces and removes oxidation. Also great for soldering brass, steel, iron, tin, lead, terne plate, galvanized steel, & tin plated aluminum fittings.

Locke#

M0813 4oz. Jar Copper-Mate Flux

LA-CO. REGULAR SOLDER FLUX



Solder copper, makes it possible to solder alum. to copper assemblies. Contains no harmful ingredients, even if ingested. Leakproof soldering every time with any soft solder.

Locke# NON-TOXIC!

M0750 4 oz. Regular Solder Flux

M0892 1 Lb. Regular Solder Flux

S.O.S. ODORLESS FLUX



Lead free, greenless, odorless. With brush. No cleaning.

Locke#

M0745 ½ Pint Solder Flux

Oatey #5 PASTE FLUX



Cleans and fluxes at the same time. 100% lead free. NSF listed.

Locke#

M0893 8oz. Paste Flux

M0894 1Lb. Paste Flux

*Thank You
For Your
Business!*

RECTORSEAL NOKORODE® AQUA FLUX™



Meets ASTM B-813 standards requiring that fluxes be water "washable" and can be flushed from the piping system to prevent corrosion. For use with 95/5, 60/40, 50/50, 40/60 and other solders.

Locke#

M1778 Nokorode Aqua Flux 4 Oz

M1779 Nokorode Aqua Flux 16 Oz

RECTORSEAL NOKORODE® REGULAR PASTE FLUX



A lead free, all purpose, soft soldering paste flux ideal for use with 95/5 and other common solders. Special oil base protects the solder joint against corrosive attack. It cleans and fluxes all at one time. Ideal on copper and brass.

Locke#

M1766 8oz. Paste Flux

RECTORSEAL C-FLUX



- Pre-cleans & Pre-tins
- For leak free joints
- Lead free
- High quality

Locke#

M0763 C-Flux - ½ Pint

M0764 C-Flux - 3 ounces

M | MISCELLANEOUS