

WASHING MACHINE OUTLET BOX

696 SERIES

OxBox™

ITEM # SUBMITTED	_____
JOB NAME	_____
LOCATION	_____
ENGINEER	_____
CONTRACTOR	_____
PO#	_____ TAG _____

SPECIFICATION

Sioux Chief 696 OxBox™ shall be used in residential or commercial plumbing supply/drainage systems. Unit shall accommodate supply lines from above or below. Unit is designed to be secured directly over vertical stud using box clip or between studs using galvanized bracket (provided). When necessary, each box may be installed in separate stud bays. Supply box options shall include plain valves or valves with water hammer arresters. Valve options shall accommodate all common industry inlet connections. Drain box design shall include 5/8" integral test nipple with knock out. Outlet connections shall be 3/4". Every unit shall include debris cover for protection during rough-in.

INSTALLATION

Each two-box outlet box assembly includes box clip and adjustable bracket. Fasten box clip to each box then install directly over vertical stud (recommended) or use bracket and install within the same stud bay. Insert bracket through molded channel on box. Secure bracket to structure and box with screws (not provided). Mounting tabs with holes located on sides of box allows boxes to be installed directly to a stud. Boxes may be stacked as an alternative installation. Minimum space requirement between boxes is 1 3/4".

MATERIALS

- Outlet box:** ABS
- Frame:** fire-rated ABS
- Valve body:** chrome-plated forged brass
- Arrester clip/valve platform:** ABS
- Arrester body:** stainless steel
- Piston:** glass-filled polypropylene with two EPDM o-rings
- Bracket:** galvanized steel, 18-ga.
- Box clip:** galvanized steel, 18-ga.

CERTIFICATIONS/APPROVALS

NSF-372 compliant, IAPMO listed
Valves meet ASME A112.18.1

VALVE/ARRESTER WORKING LIMITS

- Max working temperature:** 250°F
- Max testing air pressure:** 100 PSIG
- Max working/testing water pressure:** 250 PSIG

DIMENSIONS

A: frame width	11 1/2"	H: supply connection	1/2" nominal or 2" O.C.
B: frame height	7 1/4"	I: drain connection	2" DWV
C: frame opening width	3 5/8"	J: outlet connection	3/4" male hose thread
D: frame opening height	5 1/8"	K: test nipple	5/8" O.D.
E: rough-in box width	4" (single box) or 10" (double with clip)	L: secondary drainage knockout†	funnel accepts 1/2", 3/4" or 1" pipe
F: rough-in box depth	3 1/2"	M: bracket length	18"
G: rough-in box height	5 1/2"	N: bracket width	5/8"

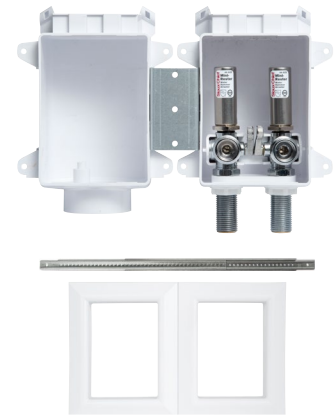

696-2313MF

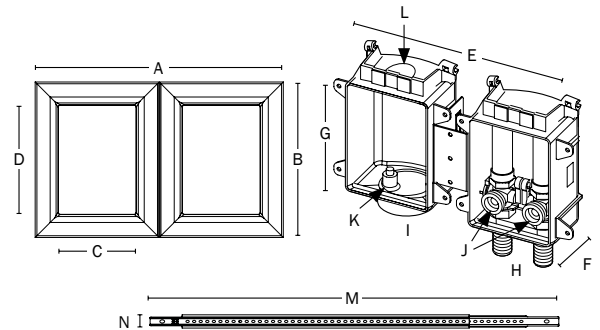

Create Item Number

696A23B3CD

e.g. 696-2313MF: washing machine supply box, drain box, MIP/FSWT valve with arrester, frame included

VALVES A

- = plain valve
- G = no lead valves

ARRESTER B

- 0 = no arrester
- 1 = with arrester

SUPPLY CONNECTION C

- A = 1/2" PEX F2080 Lock™
- C = 1/2" male CPVC
- M = 1/2" female sweat
- V = 1/2" Viega PureFlow® PEX
- W = 1/2" PEX F1960 Grip™
- X = 1/2" PEX F1807 Crimp™

FRAME OPTION D

- F = standard pack (supply and drain box, frame, bracket, debris cover)
- R = rough-in pack (supply and drain box, bracket, debris cover)

Available separately:
Frame only: (696-2F)
†Secondary drainage funnel: (696-CF)